



**PASCO COUNTY BOARD OF COUNTY COMMISSIONERS
PURCHASING DEPARTMENT
8919 GOVERNMENT DRIVE
NEW PORT RICHEY, FLORIDA 34654**

**TELEPHONE: (727) 847-8194
FACSIMILE: (727) 847-8065
pascocountyfl.net**

INVITATION FOR BIDS

BID NO. 06-185F

AUTOMOBILES AND TRUCKS

SUMMARY OF WORK

It is the intent of this solicitation to contract with a company to procure automobiles and trucks for the Pasco County's Fleet Management Department.

The Pasco County Purchasing Department will receive sealed bids until 2:00 p.m., local time (our clock), on October 26, 2006, in the Pasco County Purchasing Department, 8919 Government Drive, New Port Richey, Florida. Bids received after this time will not be accepted. Bids will be publicly opened and read at the above-stated time and date. All interested parties are invited to attend. Bidders shall submit one (1) original bid form.

Please immediately advise of address changes or if you wish to have your firm removed from the vendor list. Vendors receiving this notice must submit either a bid/proposal or "NO BID" to remain on our vendor list for the specified commodity or service. A "NO BID" is provided on Page 2 for your convenience.

This cover is only intended to inform vendors of a pending Invitation for Bid or Request for Proposal. For complete details, please refer to the complete bid/proposal package.

Bid documents may be downloaded by visiting www.PascoCountyFL.net or by requesting copies from the Purchasing Department at no cost. Pasco County is not responsible for expenses incurred prior to award by the Board of County Commissioners (BCC).

Frank C. Aleskwiz
Buyer



**PASCO COUNTY BOARD OF COUNTY COMMISSIONERS
PURCHASING DEPARTMENT
8919 GOVERNMENT DRIVE
NEW PORT RICHEY, FLORIDA 34654**

STATEMENT OF NO BID

We, the undersigned, have declined to submit a bid response to Invitation for Bid No. 06-185F for the following reason(s):

Please check all that apply.

1. Opening date does not allow sufficient time to complete bid response.
2. We do not offer the commodities or services requested.
3. Our schedule would not permit us to perform.
4. We are unable to meet the issued specification.
5. Specifications are restrictive (please explain below).
6. We are unable to meet the surety requirements.
7. Other: _____

Explanations: _____

We understand that if a "NO BID" is not returned, our firm will be removed from the bidders' list for the subject commodity.

Name: _____

Signature: _____

Company: _____

Address: _____

City/State/Zip: _____

Telephone: _____

Facsimile: _____

Fed. ID No.: _____

IMPORTANT!—PLEASE READ CAREFULLY BEFORE MAKING BID

GENERAL PROVISIONS

These general terms and conditions of the bid quotation and acceptance apply in like force to this inquiry and to any subsequent contract resulting therefrom.

ACKNOWLEDGMENT OF AMENDMENTS

Bidders shall acknowledge receipt of any amendment to the solicitation by identifying the amendment number in the space provided for this purpose on the bid form, by letter, or by returning a copy of the issued amendment with the submitted bid. The acknowledgment must be received by Pasco County by the time and at the place specified for the receipt of bids. Failure to acknowledge an issued amendment may result in bid rejection and disqualification.

ADDITIONAL INFORMATION

Questions concerning the contract or technical portions of the bid document must be submitted in writing to Scott P. Stromer, Purchasing Director, Pasco County Purchasing Department; 8919 Government Drive; New Port Richey, Florida 34654; facsimile (fax) machine number (727) 847-8065. Bidders are cautioned that any statements made by individuals, or employees of Pasco County, that materially change any portion of the bid document shall not be relied upon unless subsequently ratified by a formal written amendment to the bid document. No contractual or technical questions will be accepted after ten (10) days prior to the date set for bid opening.

ALTERNATIVE BIDS

The bidder **WILL NOT** be allowed to offer more than one (1) price (for the goods or services specified). If the said bidder should submit more than one (1) price on any item (or service), ALL prices will be rejected for that item. The bidders offering service delivery methods other than those permitted by the scope of work or specifications may submit a separate envelope clearly marked "Alternative Bid." Alternative bids will be deemed nonresponsive and will not be considered for award. All such responses will, however, be examined prior to award. Such examination may result in cancellation of all bids received to permit rewriting the scope of work or specifications to include the alternative method, or the alternative method may be considered for future requirements of Pasco County.

ANTITRUST

By entering into a contract, the contractor conveys, sells, assigns, and transfers to Pasco County all rights, titles, and interest it may now have or hereafter acquire under the antitrust laws of the United States and the State of Florida that relate to the particular goods or services purchased or acquired by Pasco County under the said contract.

APPLICABLE LAW

The contract shall be governed in all respects by the laws of the State of Florida, and any litigation with respect thereto shall be brought in the courts of Pasco County, Florida. The contractor shall comply with all applicable Federal, State, and local laws and regulations. Lack of knowledge by the bidder will in no way be a cause for relief from responsibility.

ASSIGNMENT

The contractor shall not assign, transfer, convey, sublet, or otherwise dispose of any award or any or all of its rights, title, or interest therein, or delegate the duties hereunder without the prior written consent of Pasco County.

AWARD

Consideration for award will be by proximity to specifications given, costs, and time of delivery. All purchases, leases, or contracts that are based on competitive bids will be awarded to the lowest, responsive, and responsible bidder. Complete and accurate responses to all items are necessary for the complete and fair evaluation of bids. Bid award, in addition to the above stated, will be based on compliance with the specified requirements as well as the "total-cost" or "life-cycle costing" concept, including the following: 1) Cost: A cost analysis will be conducted and will include all identifiable costs associated with acquisition, installation, maintenance, and operation of the bidder's offered equipment. The analysis will be based upon the bidder's proposal data and other costs which, in the judgment of the evaluators, will be incurred by Pasco County resulting from acceptance of the bidder's proposal; 2) Equipment: Evaluation of equipment will be based on compliance with the specifications, expected life of equipment, output, maintenance, consumption, disposal value, warranty, complexity of operation, required training, and other factors that may contribute to the overall cost of the specified item; and 3) Bidder's Reputation and Experience: Evaluation of the bidder's reputation, past performance, and experience shall be based on the nature and extent of company data furnished, references and financial responsibility of the bidder. Pasco County reserves the right to award by item, group of items, or lowest total, whichever is deemed to be in Pasco County's best interest.

BID ACCEPTANCE PERIOD

Any bid submitted as a result of the solicitation shall be binding on the bidder for a minimum of ninety (90) calendar days following the bid opening date. Any bid for which the bidder specifies a shorter acceptance period may be rejected.

BID CLARIFICATIONS

If any party contemplating the submission of a bid on this invitation is in doubt as to the true meaning of any part of the plans, specifications, or other documents, he should submit a written request for an interpretation thereof to the Purchasing Director. The bidder's concerns, regarding clarification of specifications and/or discrepancies and/or omissions and/or changes to the attached specifications shall be made in writing and received by Pasco County no later than ten (10) calendar days prior to the bid opening date. The letter from the bidder shall state clearly, and in detail, the basis for such concern(s) or request(s). The letter shall be addressed to the Purchasing Director, and marked "PREBID QUESTION" on the face of the envelope. The Purchasing Director will respond in writing. An interpretation of the bid invitation document will be made only by addendum duly issued to each party receiving a bid invitation. All such addenda shall become part of the contract documents. Pasco County shall not be responsible for explanations or interpretations of bid invitation documents except as issued in accordance herewith. No oral interpretations will be made as to the meaning of specifications or any other contract documents. Failure to comply with this provision will result in the bidder waiving his/her right to dispute the bid specification.

BIDDER CERTIFICATION

The bidder agrees that submission of a signed bid form is certification that the bidder will accept an award made to it as a result of the submission.

BIDDER INVESTIGATIONS

Before submitting a bid, each bidder shall make all investigations and examinations necessary to ascertain all site conditions and requirements affecting the full performance of the contract and to verify any representations made by Pasco County upon which the bidder will rely. If the bidder receives an award as a result of its bid submission, failure to have made such investigations and examinations will in no way relieve the bidder from its obligation to comply in every detail with all provisions and requirements of the contract documents, nor will a plea of ignorance of such conditions and requirements be accepted as a basis for any claim whatsoever by the contractor for additional compensation.

BIDDERS' LIST

Failure to submit a bid for the item(s) specified will result in removal from the bidders' list for such (an) item(s). If a bid is not submitted, a "NO BID" response must be submitted to remain on the Pasco County's bidders' list for such items. A form for submitting a "NO BID" is provided on Page 2 for your convenience.

BID ENVELOPES

Envelopes containing bids must be sealed and marked in the lower left-hand corner with the invitation number, commodity, and date and hour of opening of bids. Failure to do so may cause bid not to be considered. Express Company or Express Mail envelopes containing a sealed bid shall also be sealed and marked in the lower left-hand corner with the invitation number, commodity, and date and hour of opening of bids.

BID FORM SUBMISSION

Bids shall be submitted on the attached forms. Bids concerning separate bid invitations must not be combined on the same form or placed in the same envelope. Bids submitted in violation of this provision shall not be considered. All bids must be signed, in ink, in order to be considered. Erasures are not acceptable on bids; if necessary to make a change, strike out or draw a line through incorrect item and type the correction above, and initial the correction in ink. If the bidder is a firm or corporation, the bidder must show the title of the individual executing the bid, and if the individual is not an officer of the firm or corporation, the bidder must submit proof that the individual has the authority to obligate the firm or corporation. **BIDS MAY NOT BE ALTERED OR AMENDED AFTER THE BID CLOSING.**

BID RECEIPT AND OPENING

Pasco County will receive sealed bid proposals until date and time indicated on bid cover. Bids must be delivered, by hand or mail, to the Pasco County Purchasing Department, located at 8919 Government Drive, New Port Richey, Florida, where they will be opened at the stated time. Bids must be time stamped in the Purchasing Department before or on the hour and date indicated on the cover sheet (Invitation for Bid) for the bid opening. Bids received after the date and time of the bid opening will be received, date stamped, and returned to the bidder unopened. It is the responsibility of the bidder to ensure that bids arrive at the designated opening place on time. Late or nondelivery due to mail or express delivery company failure will not be considered adequate reason for consideration of late bids. **FAXED BIDS WILL NOT BE ACCEPTED AND SHALL NOT BE CONSIDERED FOR EVALUATION OR AWARD.** Notes may be taken at the public reading of the bid(s) at the specified time and date of the opening or a personal inspection may be made of the bid(s) after award has been made and documents are placed in central and public files.

BID WITHDRAWAL

Bids may not be changed after the bid closing time.

To withdraw a bid that includes a clerical error after bid opening, the bidder must give notice in writing to Pasco County of claim or right to withdraw a bid. Within two (2) business days after the bid opening, the bidder requesting withdrawal must provide to Pasco County all original work papers, documents, and other materials used in the preparation of the bid. A bidder may also withdraw a bid prior to the time set for the opening of bids by simply making a request in writing to Pasco County; no explanation is required. No bidder who is permitted to withdraw a bid shall, for compensation, supply any material or labor to or perform any subcontract or other work for the person to whom the contract is awarded or otherwise benefit from the contract. No partial withdrawals of a bid are permitted after the time and date set for the bid opening; only complete withdrawals are permitted. The decision to allow or disallow bid withdrawal remains solely with Pasco County.

BRAND NAMES

Any catalog, brand name, or manufacturer's reference used in the specifications is intended to be descriptive and not restrictive, and is used **only** to indicate type and quality desired. Any article, equipment, or material, which shall conform to the standards and excellence, so established, and is of equal merit, strength, durability, and appearance to perform the desired function, is deemed eligible for offer as a substitute. The qualifications of the offering shall be judged as to their conformance with these specifications. Any equipment offered other than herein specified shall be subject to a competitive demonstration and evaluation by Pasco County. The determination as to whether any alternate product or service is or is not equal shall be made by Pasco County, and such determination(s) shall be final and binding upon all bidders.

CANCELLATION

Pasco County reserves the right to cancel a resulting contract, without cause, by giving thirty (30) days' prior written notice to the contractor of the intention to cancel, or with cause if at any time the contractor fails to fulfill or abide by any of the terms or conditions specified. Failure of the contractor to comply with any of the provisions of a resulting contract shall be considered a material breach of contract and shall be cause for immediate termination of the contract at the sole discretion of Pasco County. In addition to all other legal remedies available to Pasco County, Pasco County reserves the right to cancel and obtain from another source, any services which have not been provided within the required period of time or, if no such time is stated, within a reasonable period of time from the date of order or request, as determined by Pasco County.

CERTIFICATION OF INDEPENDENT PRICE DETERMINATION

The bidder certifies that the prices submitted in response to the solicitation have been arrived at independently and without—for the purpose of restricting competition—any consultation, communication, or agreement with any other bidder or competitor relating to those prices, the intention to submit a bid, or the methods or factors used to calculate the prices bid.

CHANGE IN SCOPE OF WORK

Pasco County may order changes in the work consisting of additions, deletions, or other revisions within the general scope of the contract. No claims may be made by the contractor that the scope of the project or of the contractor's services has been changed, requiring changes to the amount of compensation to the contractor or other adjustments to the contract, unless such changes or adjustments have been made by written amendment to the contract or

purchase order signed by Purchasing Director. If the contractor believes that any particular work is not within the scope of the project, is a material change, or will otherwise require more compensation to the contractor, the contractor must immediately notify Pasco County in writing of this belief. If Pasco County believes that the particular work is within the scope of the contract as written, the contractor will be ordered to and shall continue with the work as changed and at the cost stated for the work within the scope.

COLLUSION AMONG BIDDERS

Each bidder, by submitting a bid, certifies that it is not a party to any collusive action or any action that may be in violation of the Sherman Antitrust Act. Any or all bids shall be rejected if there is any reason for believing that collusion exists among the bidders. Pasco County may or may not, at its discretion, accept future bids for the same work from participants in such collusion. More than one (1) bid from an individual, firm, partnership, cooperation, or association under the same or different names may be rejected. Reasonable grounds for believing that a bidder has interest in more than one (1) bid for the work being bid may result in rejection of all bids in which the bidder is believed to have interest. Nothing in this clause shall preclude a firm acting as a subcontractor to be included as a subcontractor for two (2) or more primary contractors submitting a bid for the work.

CONFLICT OF INTEREST

The contractor, by submission of its proposal, certifies that to the best of his/her knowledge or belief, no elected/appointed official or employee of Pasco County is financially interested, directly or indirectly, in the offer of goods or services specified in this invitation.

DEBARMENT

By submitting a bid, the bidder certifies that it is not currently debarred from submitting bids for contracts issued by any political subdivision or agency of the State of Florida and that it is not an agent of a person or entity that is currently debarred from submitting bids for contracts issued by any subdivision or agency of the State of Florida.

ERRORS IN EXTENSIONS

If the unit price and the extension price are at variance, the unit price shall prevail.

ETHICS IN PUBLIC PROCUREMENT

The contract shall incorporate by reference, but shall not be limited to, the provisions of law contained in Chapter 112, Florida Statutes. A person or affiliate who has been placed on the convicted vendor list following a conviction for a public entity crime may not submit a bid on a contract to provide any goods or services to a public entity; may not submit a bid on a contract with a public entity for the construction or repair of a public building or public work; may not submit bids on leases or real property to a public entity; may not be awarded or perform work as a contractor, supplier, subcontractor, or consultant under a contract with any public entity; and may not transact business with any public entity in excess of the threshold amount provided in Section 287.017, Florida Statutes, for CATEGORY TWO for a period of thirty-six (36) months from the date of being placed on the convicted vendor list. The bidder certifies that its bid was made without collusion or fraud; that it has not offered or received any kickbacks or inducements from any other bidder, supplier, manufacturer, or subcontractor in connection with this bid; and that it has not conferred on any public employee having official responsibility for this procurement transaction any payment, loan, subscription, advance, deposit of money, services, or anything of value.

EXCEPTIONS

Bidders taking exception to any part or section of the solicitation shall indicate such exceptions on the bid form or appendix. Failure to indicate any exception will be interpreted as the bidder's intent to comply fully with the requirements as written. Conditional or qualified bids, unless specifically allowed, shall be subject to rejection in whole or in part.

EXPENSES INCURRED IN PREPARING BID

Pasco County accepts no responsibility for any expense incurred by the bidder in the preparation and presentation of a bid. Such expenses shall be borne exclusively by the bidder.

FAILURE TO DELIVER

In the event of failure of the contractor to deliver the goods and services in accordance with the contract terms and conditions, Pasco County may procure the goods and services from other sources and hold the contractor responsible for any resulting additional costs. A failure to deliver will result in immediate termination of a resulting contract, and immediate disqualification and debarment from submitting bids to Pasco County for a maximum of three (3) years. These remedies shall be in addition to any other remedies that Pasco County may have available.

FAILURE TO ENFORCE

Failure by Pasco County at any time to enforce the provisions of the contract shall not be construed as a waiver of any such provisions. Such failure to enforce shall not affect the validity of the contract or any part thereof or the right of Pasco County to enforce any provision at any time in accordance with its terms.

FAIR LABOR STANDARDS

By submission of a bid, the bidder certifies that the contractor(s) and/or subcontractor(s) providing product(s) or service(s) shall, in the execution or performance of such a contract, maintain fair labor standards as defined in applicable State and Federal regulations.

FORCE MAJEURE

The contractor shall not be held responsible for failure to perform the duties and responsibilities imposed by the contract due to legal strikes, fires, riots, rebellions, and acts of God beyond the control of the contractor, unless otherwise specified in the contract.

IDENTICAL BIDS

Identical bids or bids which otherwise appear suspicious will be reported to the County Attorney for investigation.

INDEMNIFICATION

In consideration of the sum of Fifteen and 00/100 Dollars (\$15.00), the receipt and sufficiency of which is acknowledged by the contractor to be included and paid for in the contract price, the contractor shall indemnify, defend, and hold harmless Pasco County and its agents and employees from and against all liabilities, claims, damages, losses, and expenses, including attorneys' fees, arising out of or resulting from the performance of the work, provided that any such liability, claim, damage, loss, or expense: 1) is attributable to bodily injury, sickness, disease or death, or to injury to or destruction of tangible property (other than the work itself), including the loss of use resulting therefrom; and 2) is caused in whole or in part by any negligent act or omission of the contractor and subcontractor, anyone directly or indirectly employed by any of them, or anyone for whose acts any of them may be liable, except for those caused by the negligent act or omission of Pasco County.

In any and all claims against Pasco County or any of its agents or employees by any employee of the contractor, any subcontractor, anyone directly or indirectly employed by any of them, or anyone for whose acts any of them may be liable, the indemnification obligation under the previous paragraph shall not be limited in any way as to the amount or type of damages, compensation, or benefits payable by or for the contractor or any subcontractor under Workers' Compensation Acts, disability benefit acts, or other employee benefit acts.

INDEPENDENT CONTRACTOR

The contractor shall be legally considered an independent contractor and neither the contractor nor its employees shall, under any circumstances, be considered servants or agents of Pasco County; and Pasco County shall be at no time legally responsible for any negligence or other wrongdoing by the contractor, its servants, or agents. Pasco County shall not withhold from the contractor any Federal or State unemployment taxes, Federal or State income taxes, Social Security tax, or any other amounts for benefits to the contractor. Further, Pasco County shall not provide to the contractor any insurance coverage or other benefits, including workers' compensation, normally provided by Pasco County for its employees.

INFORMALITIES AND IRREGULARITIES

Pasco County has the right to waive minor defects or variations of a bid from the exact requirements of the specifications that do not affect the price, quality, quantity, delivery, or performance time of the services being procured. If insufficient information is submitted by a bidder with the bid for Pasco County to properly evaluate the bid, Pasco County has the right to require such additional information as it may deem necessary after the time set for receipt of bids, provided that the information requested does not change the price, quality, quantity, delivery, or performance time of the services being procured. The BCC reserves the right to reject any or all bids in whole or in part; to award by any item, group(s) of items, total bid, or accept the bid that is most advantageous and in the best interest of Pasco County.

LIMITATION OF COST

The contractor agrees to perform the work specified and complete all obligations under the contract within the stated amounts.

NONAPPROPRIATION

All funds for payment by Pasco County under this contract are subject to the availability of an annual appropriation for this purpose by Pasco County. In the event of nonappropriation of funds by Pasco County for the services provided under the contract, Pasco County will terminate the contract, without termination charge or other liability, on the last day of the then-current fiscal year or when the appropriation made for the then-current year for the services covered by this contract is spent, whichever event occurs first. If at any time funds are not appropriated for the continuance of this contract, cancellation shall be accepted by the contractor on thirty (30) days' prior written notice, but failure to give such notice shall be of no effect, and Pasco County shall not be obligated under this contract beyond the date of termination.

NONCONFORMING TERMS AND CONDITIONS

A bid response that includes terms and conditions that do not conform to the terms and conditions in the bid document is subject to rejection as nonresponsive. Pasco County reserves the right to permit the bidder to withdraw nonconforming terms and conditions from its bid response prior to a determination by Pasco County of nonresponsiveness based on the submission of nonconforming terms and conditions.

NONDISCRIMINATION

By submission of bid, the bidder certifies that the contractor(s) and/or subcontractor(s) providing product(s) or service(s) shall not discriminate against any employee or applicant for employment, to be employed in the performance of such contract, with respect to his/her hire, tenure, terms, conditions, or privileges of employment, because of his/her race, color, religion, sex, disability, or national origin, as outlined in applicable State and Federal regulations.

ORAL STATEMENTS

No oral statement of any person shall modify or otherwise affect the terms, conditions, or specifications stated in this contract. All modifications to the contract or purchase order must be made in writing by Pasco County.

PATENTS AND ROYALTIES

The contractor covenants to save, defend, keep harmless, and indemnify Pasco County and all of its officers, departments, agencies, agents, and employees from and against all claims, loss, damage, injury, fines, penalties, and cost—including court costs and attorney's fees, charges, liability, and exposure, however caused—for or on account of any copyright or patented or unpatented invention, process, or article manufactured or used in the performance of the contract, including its use by Pasco County. If the contractor uses any design, device, or materials covered by patent or copyright, it is mutually agreed and understood without exception that the contract price includes all royalties or costs arising from the use of such design, device, or materials in any way in the work.

PAYMENT PROCEDURES

The BCC has adopted Resolution No. 95-70, incorporating its Invoice Payment Procedures Policy in order to help ensure that vendors providing goods and/or services to the BCC receive payment in a timely manner and in accordance with Chapter 218, Part VII, Florida Statutes (The Florida Prompt Payment Act). A copy of Resolution No. 95-70 (which includes the policy) is available for viewing during normal business hours at the Office of the Pasco County Clerk of the Circuit Court; 38053 Live Oak Avenue; Department of Secretarial Services, Room 205; Dade City, Florida 33525. Copies of the Resolution may be obtained at a cost of One and 20/100 Dollars (\$1.20). Please make your check payable to Jed Pittman, Clerk of the Circuit Court, and forward payment to the Department of Secretarial Services at the address noted above. For further information, please call (352) 521-4347.

Several payment options are available to successful vendor, upon receipt of a correct invoice:

1. Check may be mailed to the remit address on the invoice. The check is sent to the Post Office the day after BCC approval.
2. Check may be picked up in Dade City. The vendor must pick up the check the day after BCC approval. The successful bidder or contractor must call (352) 521-4599 for detailed instructions.
3. Payment may be wire-transferred to the vendor's bank account. The vendor must call (352) 521-4599 for detailed instructions.

PAYMENT TERMS AND DISCOUNTS

Unless otherwise indicated in the bid documents, payment terms will be net forty-five (45) days. Terms not consistent with this provision are not acceptable and may be cause for rejection. Pasco County will pay the contractor within forty-five (45) days after the receipt of a correct invoice for reasonable work allocable to the contract or after the date of acceptance of work that

meets contract requirements, whichever event occurs later. Payment(s) are considered effective on the date payment is mailed.

Discounts for prompt payment requiring payment by Pasco County within a stipulated number of days will be interpreted as applying within the stipulated number of calendar days after the date of receipt by Pasco County of a correct invoice describing reasonable work allocable to the contract or after the date of acceptance of work that meets contract requirements, whichever event occurs later. Discounts for payment in less than forty-five (45) days will not be considered during evaluation for award, but may be taken if applicable after award.

Payment for construction services will be in accordance with Chapter 218, Part VII, Florida Statutes (The Florida Prompt Payment Act).

PROCUREMENT REGULATIONS

A copy of the Pasco County Procurement Ordinance is available for review at Pasco County Purchasing Department, 8919 Government Drive, New Port Richey, Florida.

PUBLIC INFORMATION

Upon public opening of all bids or proposals presented to Pasco County as a result of this solicitation, any and all information contained therein is considered public and may be reviewed by any persons interested in doing so.

PURCHASE ORDER REQUIREMENT

Purchases of Pasco County are authorized only if a signed purchase order issued in advance of the transaction, showing that the ordering agency has sufficient funds available to pay for the service. Contractors providing services without a signed purchase order do so at their own risk. Pasco County will not be liable for payment for any services provided under the contract unless a valid purchase order has been issued to the contractor.

QUALIFICATIONS OF BIDDERS

The bidder may be required before the award of any contract to show to the complete satisfaction of Pasco County that it has the necessary facilities, ability, and financial resources to provide the service specified therein in a satisfactory manner. The bidder may also be required to give a past history and references in order to satisfy Pasco County in regard to the bidder's qualifications. Pasco County may make reasonable investigations deemed necessary and proper to determine the ability of the bidder to perform the work, and the bidder shall furnish to Pasco County all information for this purpose that may be requested. Pasco County reserves the right to reject any bid if the evidence submitted by, or investigation of, the bidder fails to satisfy Pasco County that the bidder is properly qualified to carry out the obligations of the contract and to complete the work described therein. Evaluation of the bidder's qualifications shall include:

1. The ability, capacity, skill, and financial resources to perform the work or provide the service required.
2. The ability of the bidder to perform the work or provide the service promptly or within the time specified, without delay or interference.
3. The character, integrity, reputation, judgment, experience, and efficiency of the bidder.
4. The quality of performance of previous contracts or services.

QUALITY OF GOODS

All goods shall be new, in first class condition, and of the manufacturer's latest design of the model presently in production. All materials, supplies, and equipment furnished or services performed under the terms of this purchase order or contractual agreement shall comply with the requirements and standards specified in the Williams-Steiger Occupational Safety and Health Act of 1970 (Public Law 91-596), as well as other applicable Federal, State, and local codes. Equipment and materials furnished by the bidder having serious defects, corrosion, or scratches which tend to present an "other than new" appearance shall be promptly replaced or such defects promptly corrected by the bidder at no cost to Pasco County. Any existing Material Safety Data Sheets (MSDS) for the products, materials, supplies, or equipment being bid must be submitted with the bid. No product containing asbestos, lead paint, or polychlorinated biphenyl (PCB) in any form will be considered for award by Pasco County.

RECOVERY OF MONEY

Whenever, under the contract, any sum of money shall be recoverable from or payable by the contractor to Pasco County, the same amount may be deducted from any sum due the contractor under the contract or under any other contract between the contractor and Pasco County. The rights of Pasco County are in addition and without prejudice to any other right Pasco County may have to claim the amount of any loss or damage suffered by Pasco County on account of the acts or omissions of the contractor.

RIGHT TO AUDIT

The contractor shall maintain such financial records and other records as they relate to the purchase of goods and/or services by Pasco County from the subject vendor. The contractor shall retain these records for a period of three (3) years after final payment, or until they are audited by Pasco County, whichever event occurs first. These records shall be made available during the term of the contract and the subsequent three (3) year period for examination, transcription, and audit by Pasco County, its designees, or other authorized bodies.

RISK OF LOSS

Pasco County shall be relieved from all risks of loss or damage to goods during periods of transportation, manufacture, and the entire time the goods are in the possession of Pasco County prior to acceptance by Pasco County. At such time, the risk of loss or damage for goods shall pass to Pasco County. The bidder/contractor shall not be responsible for damage to the goods occasioned by negligence of Pasco County or its employees.

TABULATIONS

Solicitation results, plan holder lists, and related information may be retrieved from our website: www.PascoCountyFL.net. Click on "Bids," click on "closed solicitations," and look for the solicitation number in the appropriate year. Solicitation results will normally be available online within three (3) working days after opening. Lengthy tabulations may not be available online, but may be viewed in the Purchasing Department. Plan holder lists will normally be available two (2) weeks prior to opening. Plan holder lists will be posted once, based on the information at the time, and will not be updated. Tabulations will not be given over the telephone or via fax.

TAXES

All bids shall be submitted exclusive of direct Federal, State, and local taxes; however, if the bidder believes certain taxes are properly payable, he/she may list such taxes separately in each case directly below the respective item bid price. Prices quoted must be in units specified, and shall not include the cost of any such taxes, including those on any material, supplies, or equipment used or installed in the work. Pasco County does not pay Federal Excise and Sales

Taxes on direct purchases of tangible personal property. See Exemption Number on face of the resulting purchase order. This exemption does not apply to purchases of tangible personal property made by contractors who use the tangible personal property in the performance of contracts for improvement of County-owned real property. Please refer to Chapter 192, Florida Statutes.

UNSATISFACTORY WORK

If, at any time during the contract term, the service performed or work done by the contractor is considered by Pasco County to create a condition that threatens the health, safety, or welfare of the community, the contractor shall, on being notified by Pasco County, immediately correct such deficient service or work. In the event the contractor fails, after notice, to correct the deficient service or work immediately, Pasco County shall have the right to order the correction of the deficiency by separate contract or with its own resources at the expense of the contractor. Notwithstanding the above, Pasco County reserves the right to cancel a resulting contract, without cause, by giving thirty (30) days' prior written notice to the contractor of the intention to cancel.

END OF GENERAL PROVISIONS

SPECIAL PROVISIONS

In addition to the General Provisions of this solicitation, these Special Provisions, along with the specifications that follow, apply in like force to this solicitation and to any subsequent contract resulting therefrom.

MOTOR VEHICLE INDUSTRY LICENSING

The contractor shall comply with Chapter 320, Florida Statutes. Failure to comply may result in a determination of nonresponsibility on the basis that the bidder is not qualified to legally contract with Pasco County and may further cause such noncompliant offers to be rejected.

TRANSPORTATION AND PACKING

Prices quoted shall be net, including transportation and delivery charges fully prepaid by the seller, f.o.b. New Port Richey, Florida 34654. No additional charges will be allowed for packing, packages, or partial delivery costs. By submitting their bids, all bidders certify and warrant that the price offered for f.o.b. destination includes only the actual freight rate costs at the lowest and best rate and is based upon actual weight of the goods to be shipped. Standard commercial packaging, packing, and shipping containers shall be used, except as otherwise specified herein.

END OF SPECIAL PROVISIONS

ITEM NO. 1

COMPACT PICKUP TRUCK (4 X 2) EXTENDED CAB SPECIFICATIONS

1.0 ENGINE:

- 1.1 Gasoline engine, six (6) cylinder, minimum 3.0L, or approved equivalent.
- 1.2 Minimum ninety (90) amp alternator, heavy-duty battery.

2.0 TRANSMISSION:

- 2.1 Automatic transmission.

3.0 AXLES:

- 3.1 Manufacturer's standard rear axle ratio for specified engine-transmission combination.

4.0 PERFORMANCE ITEMS:

- 4.1 Factory-installed gauges.

5.0 COMFORT ITEMS:

- 5.1 Factory-installed air conditioning.
- 5.2 Tinted glass, factory installed.

6.0 SAFETY ITEMS:

- 6.1 Outside mirrors, LH and RH sides, with convex glass in RH mirror; inside rearview mirror.
- 6.2 Power brakes, factory installed with ABS.
- 6.3 Power steering.
- 6.4 Air bags.
- 6.5 Side air bags if available as OEM.

7.0 TIRES & WHEELS:

7.1 Five (5) radial fifteen (15) inch or larger BSW highway or all-seasons tread tires.

7.2 Spare tire and wheel.

8.0 CHASSIS, FRAME, CAB:

8.1 Minimum 4,500 lbs. GVWR, factory certified.

8.2 Fleetside or approved equivalent body, minimum 6'0" inside. Double wall bed, one (1) piece outer wrapper, with inner wall welded (not bolted) in place.

8.3 Front bumper, heavy-duty step-type rear bumper, both factory installed.

8.4 Extended cab, not crew cab.

9.0 COLOR:

9.1 Fleet White.

10.0 CONDITIONS:

In addition to the equipment specified, the unit shall be equipped with all standard equipment specified by manufacturer for the model bid and shall comply with all EPA emission standards and meet all OSHA and DOT current standards and safety requirements.

All bidders must identify in their bid proposals any after-market parts or components not designed by the manufacturer (OEM) with reference to the vehicle or equipment being bid. Any after-market parts or components identified must have the company's name and associated warranties.

Reflective tape required to meet all State and Federal guidelines.

10.1 Manufacturer's line sheet shall be submitted upon delivery.

11.0 OPTIONS (TO BE INCLUDED):

11.1 Strobe warning lights.

- a. Unit shall be equipped with a four (4) light (two [2] front, two [2] rear) strobe light warning system. The strobe light installation kit shall be a Star Warning Systems Model No. RSK906P.4 from Star Headlight and Lantern Company, Inc., telephone (585) 226-9500, Website www.star1889.com. Front lights shall be clear, and rear lights shall be amber. This strobe light system shall be installed and operational when the vehicle is delivered.

ITEM NO. 2

COMPACT PICKUP TRUCK (4 X 4) EXTENDED CAB SPECIFICATIONS

1.0 ENGINE:

- 1.1 Gasoline engine, six (6) cylinder, minimum 3.0 L, or approved equivalent.
- 1.2 Minimum ninety (90) amp alternator; heavy-duty battery.

2.0 TRANSMISSION:

- 2.1 Automatic transmission.
- 2.2 Two (2) speed transfer case; part-time four (4) wheel drive electronic shift.

3.0 AXLES:

- 3.1 Manufacturer's standard rear axle ratio for specified engine-transmission combination, with automatic locking hubs.

4.0 PERFORMANCE ITEMS:

- 4.1 Factory-installed gauges.

5.0 COMFORT ITEMS:

- 5.1 Factory-installed air conditioning.
- 5.2 Factory tinting on all windows.

6.0 SAFETY ITEMS:

- 6.1 Outside mirrors, LH and RH sides, with convex glass in RH mirror; inside rearview mirror.
- 6.2 Power brakes, factory installed with ABS.
- 6.3 Power steering.
- 6.4 Air bags.
- 6.5 Side air bags if available as OEM.

7.0 TIRES & WHEELS:

7.1 Five (5) radial 235/75R15 or larger BSW all terrain tread tires. Spare tire and wheel.

7.2 Full-size spare.

8.0 CHASSIS, FRAME, CAB:

8.1 Minimum 4,500 lbs. GVWR, factory certified.

8.2 Fleetside or approved equivalent body, minimum 6'0" inside. Double wall bed, one (1) piece outer wrapper, with inner wall welded (not bolted) in place.

8.3 Front bumper, heavy-duty step-type rear bumper, both factory installed.

8.4 Extended cab, not crew cab.

9.0 COLOR: Fleet White.

10.0 CONDITIONS:

In addition to the equipment specified, the unit shall be equipped with all standard equipment specified by manufacturer for the model bid and shall comply with all EPA emission standards and meet all OSHA and DOT current standards and safety requirements.

All bidders must identify in their bid proposals any after-market parts or components not designed by the manufacturer (OEM) with reference to the vehicle or equipment being bid. Any after-market parts or components identified must have the company's name and associated warranties.

10.1 Reflective tape required to meet all State and Federal guidelines.

10.2 Manufacturer's line sheet shall be submitted upon delivery.

11.0 OPTIONS (TO BE INCLUDED):

11.1 Strobe warning lights.

- a. Unit shall be equipped with a four (4) light (two [2] front, two [2] rear) strobe light warning system. The strobe light installation kit shall be a Star Warning Systems Model No. RSK906P.4 from Star Headlight and Lantern Company, Inc., telephone (585) 226-9500, Website www.star1889.com. Front lights shall be clear, and rear lights shall be amber. This strobe light system shall be installed and operational when the vehicle is delivered.

ITEM NO. 3

½-TON STYLESIDE BODY PICKUP TRUCK (4 X 2) SPECIFICATIONS

1.0 ENGINE:

- 1.1 Gasoline engine, six (6) cylinder, minimum 4.2 L or approved equivalent.
- 1.2 Minimum ninety (90) amp alternator; heavy-duty battery.

2.0 TRANSMISSION:

- 2.1 Automatic transmission.

3.0 AXLES:

- 3.1 Manufacturer's standard rear axle ratio for specified engine-transmission combination.

4.0 PERFORMANCE ITEMS:

- 4.1 Factory-installed gauges.
- 4.2 Power steering.

5.0 COMFORT ITEMS:

- 5.1 Factory air conditioning.
- 5.2 Factory tinting on all windows.

6.0 SAFETY ITEMS:

- 6.1 Outside mirrors, LH and RH sides; inside rearview mirror.
- 6.2 Power brakes, factory installed with ABS.
- 6.3 Air bags.
- 6.4 Side air bags if available as OEM.

7.0 TIRES & WHEELS:

- 7.1 Five (5) sixteen (16) inch or larger radial tubeless BSW highway or all seasons tread tires. Spare tire and wheel.

8.0 CHASSIS, FRAME, CAB:

8.1 Styleside or approved equivalent body, minimum 7'11" inside.

8.2 Front bumper, heavy-duty step-type rear bumper, both factory installed.

9.0 COLOR:

9.1 Fleet White.

10.0 CONDITIONS:

10.1 In addition to the equipment specified, the unit shall be equipped with all standard equipment specified by manufacturer for the model bid and shall comply with all EPA emission standards and meet all OSHA and DOT current standards and safety requirements.

10.2 All bidders must identify in their bid proposals any after-market parts or components not designed by the manufacturer (OEM) with reference to the vehicle or equipment being bid. Any after-market parts or components identified must have the company's name and associated warranties.

10.3 Reflective tape required to meet all State and Federal guidelines.

10.4 Manufacturer's line sheet shall be submitted upon delivery.

11.0 OPTIONS (TO BE INCLUDED):

11.1 Heavy-duty towing package to include receiver.

11.2 Strobe warning lights.

- a. Unit shall be equipped with a four (4) light (two [2] front, two [2] rear) strobe light warning system. The strobe light installation kit shall be a Star Warning Systems Model No. RSK906P.4 from Star Headlight and Lantern Company, Inc., telephone (585) 226-9500, Website www.star1889.com. Front lights shall be clear, and rear lights shall be amber. This strobe light system shall be installed and operational when the vehicle is delivered.

ITEM NO. 4

$\frac{3}{4}$ -TON STYLESIDE BODY PICKUP TRUCK (4 X 2) SPECIFICATIONS

1.0 ENGINE:

- 1.1 Gasoline engine, V8, minimum 5.4 L or approved equivalent.
- 1.2 Minimum 115-amp alternator; heavy-duty battery.

2.0 TRANSMISSION:

- 2.1 Automatic transmission.

3.0 AXLES:

- 3.1 Manufacturer's standard rear axle ratio for specified engine-transmission combination.

4.0 PERFORMANCE ITEMS:

- 4.1 Factory-installed gauges.
- 4.2 Power steering.

5.0 COMFORT ITEMS:

- 5.1 Air conditioning, factory installed.
- 5.2 Factory tinting on all windows.

6.0 SAFETY ITEMS:

- 6.1 Outside mirrors, LH and RH sides; inside rearview mirror.
- 6.2 Power brakes. Factory installed with ABS.
- 6.3 Airbags.
- 6.4 Side airbags if available as OEM.

7.0 TIRES & WHEELS:

- 7.1 Five (5) sixteen (16) inch or larger radial BSW tubeless highway or all seasons tread tires.

8.0 CHASSIS, FRAME, CAB:

8.1 Minimum 9,200 GVW.

8.2 Minimum 135-inch wheelbase.

8.3 Styleside or approved equivalent body, minimum 7'11" inside.

8.4 Front bumper, heavy-duty step-type rear bumper, both factory installed.

9.0 COLOR: Fleet White.

10.0 CONDITIONS:

In addition to the equipment specified, the unit shall be equipped with all standard equipment specified by manufacturer for the model bid and shall comply with all EPA emission standards and meet all OSHA and DOT current standards and safety requirements.

All bidders must identify in their bid proposals any after-market parts or components not designed by the manufacturer (OEM) with reference to the vehicle or equipment being bid. Any after-market parts or components identified must have the company's name and associated warranties.

Reflective tape required to meet all State and Federal guidelines.

10.1 Manufacturer's line sheet shall be submitted upon delivery.

11.0 OPTIONS (TO BE INCLUDED):

11.1 Heavy-duty towing package to include receiver.

11.2 Strobe warning lights.

- a. Unit shall be equipped with a four (4) light (two [2] front, two [2] rear) strobe light warning system. The strobe light installation kit shall be a Star Warning Systems Model No. RSK906P.4 from Star Headlight and Lantern Company, Inc., telephone (585) 226-9500, Website www.star1889.com. Front lights shall be clear, and rear lights shall be amber. This strobe light system shall be installed and operational when the vehicle is delivered.

ITEM NO. 5

LARGE MID-SIZE VEHICLE, FOUR-DOOR SEDAN SPECIFICATIONS

1.0 ENGINE:

- 1.1 Gasoline engine, six (6) cylinder, minimum 3.0 L or approved equivalent.
- 1.2 Minimum 110 amp alternator; heavy-duty battery.

2.0 TRANSMISSION:

- 2.1 Automatic transmission.

3.0 AXLES:

- 3.1 Manufacturer's standard drive axle ratio for specified engine-transmission combination.

4.0 PERFORMANCE ITEMS:

- 4.1 Power steering, factory installed.
- 4.2 Cruise control.

5.0 COMFORT ITEMS:

- 5.1 Air conditioning, factory installed.
- 5.2 Factory tinting on all windows.
- 5.3 All vinyl upholstery on seats, if available.
- 5.4 Sound insulation package, if available.

6.0 SAFETY ITEMS:

- 6.1 Outside mirror, LH and RH control; inside rearview mirror.
- 6.2 Power brakes, factory installed with ABS.
- 6.3 Air bags to include side if available.

7.0 TIRES & WHEELS:

7.1 Five (5) radial BSW highway or all seasons tread tires.

7.2 Manufacturer's standard spare mounted.

8.0 CHASSIS, FRAME, CAB:

8.1 Minimum five (5) passengers.

9.0 COLOR: Fleet White.

10.0 CONDITIONS:

In addition to the equipment specified, the unit shall be equipped with all standard equipment specified by manufacturer for the model bid and shall comply with all EPA emission standards, and meet all OSHA and DOT current standards and safety requirements.

All bidders must identify in their bid proposals any after-market parts or components not designed by the manufacturer (OEM) with reference to the vehicle or equipment being bid. Any after-market parts or components identified must have the company's name and associated warranties.

10.1 Manufacturer's line sheet shall be submitted upon delivery.

ITEM NO. 6

$\frac{3}{4}$ -TON STYLE SIDE BODY PICKUP TRUCK (4 X 4) SPECIFICATIONS

1.0 ENGINE:

- 1.1 Gasoline engine, V*, minimum 5.4 L or approved equivalent.
- 1.2 Minimum ninety (90) amp alternator, heavy-duty battery.

2.0 TRANSMISSION:

- 2.1 Automatic transmission.
- 2.2 Two (2) speed transfer case; part-time four (4) wheel drive.
- 2.3 Heavy-duty trailer towing equipment (to include receiver).

3.0 AXLES:

- 3.1 Limited slip or locking differential on rear axle.

4.0 PERFORMANCE ITEMS:

- 4.1 Factory-installed gauges.
- 4.2 Power steering.

5.0 COMFORT ITEMS:

- 5.1 Factory air conditioning.
- 5.2 Factory tinting on all windows.

6.0 SAFETY ITEMS:

- 6.1 Outside mirrors, LH & RH sides; inside rearview mirror.
- 6.2 Power brakes. Factory installed with ABS.
- 6.3 Air bags.
- 6.4 Side air bags if available as OEM.

7.0 TIRES & WHEELS:

- 7.1 Five (5) sixteen (16) inch or larger radial BSW tubeless all terrain tread tires.

8.0 CHASSIS, FRAME, CAB:

8.1 Minimum of 8,500 GVW.

8.2 Fleetside or approved equivalent body, minimum 7'11" inside.

8.3 Front bumper, heavy-duty step-type rear bumper, both factory installed.

9.0 COLOR:

9.1 Fleet White.

10.0 CONDITIONS:

In addition to the equipment specified, the unit shall be equipped with all standard equipment specified by manufacturer for the model bid and shall comply with all EPA emission standards and meet all OSHA and DOT current standards and safety requirements.

All bidders must identify in their bid proposals any after-market parts or components not designed by the manufacturer (OEM) with reference to the vehicle or equipment being bid. Any after-market parts or components identified must have the company's name and associated warranties.

Reflective tape required to meet all State and Federal guidelines.

10.1 Manufacturer's line sheet shall be submitted upon delivery.

11.0 OPTIONS (TO BE INCLUDED):

11.2 Strobe warning lights.

- a. Unit shall be equipped with a four (4) light (two [2] front, two [2] rear) strobe light warning system. The strobe light installation kit shall be a Star Warning Systems Model No. RSK906P.4 from Star Headlight and Lantern Company, Inc., telephone (585) 226-9500, Website www.star1889.com. Front lights shall be clear, and rear lights shall be amber. This strobe light system shall be installed and operational when the vehicle is delivered.

ITEM NO. 7
FULL UTILITY VEHICLE (4 X 4)
SPECIFICATIONS

1.0 ENGINE:

- 1.1 Gasoline engine, V8, minimum 5.4 L or approved equivalent.
- 1.2 Minimum 110-amp alternator; heavy-duty battery.

2.0 TRANSMISSION:

- 2.1 Automatic transmission.
- 2.2 Two (2) speed transfer case; part-time four (4) wheel drive.
- 2.3 Transmission oil/air cooler.

3.0 AXLES:

- 3.1 Limited slip or locking differential on rear axle.

4.0 PERFORMANCE ITEMS:

- 4.1 Factory installed gauges.
- 4.2 Power steering.
- 4.3 HD suspension (springs and shocks, front and rear); heaviest duty available, front stabilizer bar, and (if available) rear stabilizer bar.

5.0 COMFORT ITEMS:

- 5.1 Factory tinting on all windows.
- 5.2 Air conditioning. Factory installed.
- 5.3 Armrest - both doors; sun visors - both sides.

6.0 SAFETY ITEMS:

- 6.1 Outside mirrors, LH and RH sides, low mount, minimum size 5" X 8"; inside rearview mirror.
- 6.2 Power brakes. Factory installed with ABS.
- 6.3 Air bags.
- 6.4 Side air bags if available as OEM.

7.0 TIRES & WHEELS:

7.1 Five (5) radial 305/70R16 or large on-off road tread tires. Spare tire and wheel.

8.0 CHASSIS, FRAME, CAB:

8.1 Minimum 7,000 lbs. GVWR, factory certified.

8.2 Minimum 118-inch wheelbase.

8.3 Four (4) door, five (5) passenger model (includes bucket seats for driver and RH passenger and bench rear seat).

8.4 Metal or fiberglass top, white in color, covering entire rear passenger and cargo area with windows on sides and rear. Area completely enclosed including tailgate.

8.5 Maximum heat and sound insulation and headlining available from manufacturer.

8.6 Front bumper, rear bumper, both to be factory installed.

8.7 Total fuel tank capacity minimum twenty-five (25) U.S. gallons.

8.8 Fuel tank and transfer case shields, factory installed, metal.

9.0 COLOR:

9.1 Fleet White.

10.0 CONDITIONS:

10.1 In addition to the equipment specified, the unit shall be equipped with all standard equipment specified by manufacturer for the model bid and shall comply with all EPA emission standards, and meet all OSHA and DOT current standards and safety requirements.

10.2 All bidders must identify in their bid proposals any after-market parts or components not designed by the manufacturer (OEM) with reference to the vehicle or equipment being bid. Any after-market parts or components identified must have the company's name and associated warranties.

10.3 Reflective tape required to meet all State and Federal guidelines.

10.4 Manufacturer's line sheet shall be submitted upon delivery.

11.0 OPTIONS (TO BE INCLUDED):

11.1 Strobe warning lights.

- a. Unit shall be equipped with a four (4) light (two [2] front, two [2] rear) strobe light warning system. The strobe light installation kit shall be a Star Warning Systems Model No. RSK906P.4 from Star Headlight and Lantern Company, Inc., telephone (585) 226-9500, Website www.star1889.com. Front lights shall be clear, and rear lights shall be amber. This strobe light system shall be installed and operational when the vehicle is delivered.

11.2 Auxiliary dome light.

- a. Header mounted between the sun visors. Peterson Model No. PM390 or approved equivalent. Must include in-line fuse or circuit breaker. Factory or dealer installed.

11.3 Heavy-duty towing package to include receiver and plug for electrical system. Factory installed.

- a. Trailers to 5,000 pounds.
- b. Heavy-duty cooling system.
- c. Weight distribution hitch.

ITEM NO. 8

FOUR (4) DOOR UTILITY VEHICLE (4 X 4) SPECIFICATIONS

1.0 ENGINE:

- 1.1 Gasoline engine, six (6) cylinder, with a minimum 4.0 L.
- 1.2 Minimum 110-amp alternator.

2.0 TRANSMISSION:

- 2.1 Automatic transmission.
- 2.2 Two (2) speed transfer case; part-time four (4) wheel drive.
- 2.3 Transmission oil/air cooler.

3.0 AXLES:

- 3.1 Limited slip or locking differential on rear axle.
- 3.2 Automatic locking hubs.

4.0 PERFORMANCE ITEMS:

- 4.1 Factory-installed gauges.
- 4.2 HD suspension (springs and shocks, front and rear); front stabilizer bar, and rear stabilizer bar.
- 4.3 Power steering.

5.0 COMFORT ITEMS:

- 5.1 Armrests, both doors; sun visors, both sides.
- 5.2 Factory tinting on all windows.
- 5.3 Air conditioning. Factory installed.

6.0 SAFETY ITEMS:

- 6.1 Outside mirrors, LH and RH sides, low mount, inside rearview mirror.
- 6.2 Power brakes. Factory installed. Antilock.
- 6.3 Air bags.

7.0 TIRES & WHEELS:

7.1 Five (5) sixteen (16) inch or larger radial BSW on-off road tread tires.

8.0 CHASSIS, FRAME, CAB:

8.1 Minimum 111-inch.

8.2 Four (4) door (minimum of five [5] passengers).

8.3 Maximum heat and sound insulation and headlining available from manufacturer.

8.4 Front bumper. Rear bumper, heaviest duty available. Factory installed.

8.5 Fuel tank and transfer case shields, factory installed, metal.

8.6 Minimum 5,800 GVWR.

9.0 COLOR:

9.1 Fleet White.

10.0 CONDITIONS:

10.1 In addition to the equipment specified, the unit shall be equipped with all standard equipment specified by manufacturer for the model bid and shall comply with all EPA emission standards, and meet all OSHA and DOT current standards and safety requirements.

10.2 All bidders must identify in their bid proposals any after-market parts or components not designed by the manufacturer (OEM) with reference to the vehicle or equipment being bid. Any after-market parts or components identified must have the company's name and associated warranties.

10.3 Reflective tape required to meet all State and Federal guidelines.

10.4 Manufacturer's line sheet shall be submitted upon delivery.

ITEM NO. 9

ONE (1) TON PICKUP TRUCK, CREW CAB (4 X 2) DUAL REAR WHEELS SPECIFICATIONS

1.0 ENGINE:

- 1.1 A V-8 gasoline engine with a minimum of 285 net hp.
- 1.2 Minimum 115-amp alternator, heavy-duty battery.

2.0 TRANSMISSION:

- 2.1 Automatic transmission, transmission oil-air cooler, factory installed.

3.0 AXLES:

- 3.1 Manufacturer's standard rear axle ratio for specified engine-transmission combination.
- 3.2 Heavy-duty trailer towing equipment package to include receiver.

4.0 PERFORMANCE ITEMS:

- 4.1 Factory-installed gauges.
- 4.2 Power steering.

5.0 COMFORT ITEMS:

- 5.1 Air conditioning, factory installed.
- 5.2 Factory tinting on all windows.

6.0 SAFETY ITEMS:

- 6.1 Outside mirrors, Jr. Westcoast-type, LH and RH sides; inside rearview mirror.
- 6.2 Power brakes, factory installed ABS.
- 6.3 Air bags to include side if available as OEM.

7.0 TIRES AND WHEELS:

7.1 Five (5) 215/85R16 or larger radial BSW tubeless highway or all season tread tires.

7.2 Spare tire.

8.0 CHASSIS, FRAME, CAB:

8.1 Minimum payload of 4,200 lbs.

8.2 Minimum 164.5-inch wheelbase.

8.3 Fleetside or approved equivalent body, minimum 7'11" inside.

8.4 Front bumper, heavy-duty step-type rear bumper, both factory installed.

8.5 Six (6) passenger, four (4) door crew cab with seat belts for all passengers.

9.0 COLOR:

9.1 Fleet White.

10.0 CONDITIONS:

In addition to the equipment specified, the unit shall be equipped with all standard equipment specified by manufacturer for the model bid and shall comply with all EPA emission standards and meet all OSHA and DOT current standards and safety requirements.

All bidders must identify in their bid proposals any after-market parts or components not designed by the manufacturer (OEM) with reference to the vehicle or equipment being bid. Any after-market parts or components identified must have the company's name and associated warranties.

10.1 Reflective tape required to meet all State and Federal guidelines.

10.2 Manufacturer's line sheet shall be submitted upon delivery.

11.0 OPTIONS TO BE INCLUDED:

11.1 Strobe warning lights.

- a. The unit shall be equipped with a four (4) light (two [2] front, two [2] rear) strobe light warning system. The strobe light installation kit shall be a Star Warning Systems Model RSK906P.4 from Star Headlight and Lantern Co., Inc., telephone (585) 226-9500 website www.star1889.com. This strobe light system shall be installed and operational when the vehicle is delivered.

ITEM NO. 10

$\frac{3}{4}$ -TON PICKUP TRUCK WITH UTILITY BODY (4 X 2) SPECIFICATIONS

1.0 ENGINE:

- 1.1 Gasoline engine, V8, minimum 5.4 L or approved equivalent.
- 1.2 Minimum 115-amp alternator; heavy-duty battery.

2.0 TRANSMISSION:

- 2.1 Automatic transmission.

3.0 AXLES:

- 3.1 Manufacturer's standard rear axle ratio for specified engine-transmission combination.

4.0 PERFORMANCE ITEMS:

- 4.1 Factory-installed gauges.
- 4.2 Power steering.

5.0 COMFORT ITEMS:

- 5.1 Air conditioning, factory installed.
- 5.2 Factory tinting on all windows.

6.0 SAFETY ITEMS:

- 6.1 Outside mirrors, LH and RH sides; inside rearview mirror.
- 6.2 Power brakes. Factory installed with ABS.
- 6.3 Airbags.
- 6.4 Side airbags if available as OEM.

7.0 TIRES & WHEELS:

- 7.1 Seven (7) sixteen (16) inch or larger radial BSW tubeless highway or all seasons tread tires.

8.0 CHASSIS, FRAME, CAB:

- 8.1 Minimum 9,200 GVW.
- 8.2 Minimum 135-inch wheelbase.
- 8.3 Heavy-duty utility body with backup alarm.
- 8.4 Front bumper, heavy-duty step-type rear bumper, both factory installed.
- 8.5 Minimum thirty (30) gallon fuel tank capacity.

9.0 COLOR: Fleet White.

10.0 CONDITIONS:

In addition to the equipment specified, the unit shall be equipped with all standard equipment specified by manufacturer for the model bid and shall comply with all EPA emission standards and meet all OSHA and DOT current standards and safety requirements.

All bidders must identify in their bid proposals any after-market parts or components not designed by the manufacturer (OEM) with reference to the vehicle or equipment being bid. Any after-market parts or components identified must have the company's name and associated warranties.

Reflective tape required to meet all State and Federal guidelines.

- 10.1 Manufacturer's line sheet shall be submitted upon delivery.

11.0 OPTIONS (TO BE INCLUDED):

- 11.1 Heavy-duty towing package to include receiver.
- 11.2 Strobe warning lights.
 - a. Unit shall be equipped with a four (4) light (two [2] front, two [2] rear) strobe light warning system. The strobe light installation kit shall be a Star Warning Systems Model No. RSK906P.4 from Star Headlight and Lantern Company, Inc., telephone (585) 226-9500, Website www.star1889.com. Front lights shall be clear, and rear lights shall be amber. This strobe light system shall be installed and operational when the vehicle is delivered.

ITEM NO. 11

$\frac{3}{4}$ -TON BASIC CARGO VAN SPECIFICATIONS

1.0 ENGINE:

- 1.1 Gasoline engine, V-8, minimum 5.4 L.
- 1.2 Minimum 110-amp alternator; heavy-duty battery.

2.0 TRANSMISSION:

- 2.1 Automatic transmission.

3.0 PERFORMANCE ITEMS:

- 3.1 Factory-installed gauges.
- 3.2 Power steering.
- 3.3 Antilock brakes.

4.0 COMFORT ITEMS:

- 4.1 Vinyl upholstery.
- 4.2 Vinyl trim on doors and side panels in passenger's compartment. Plain hardboard panels not acceptable.
- 4.3 Headliner with insulation over driver and passenger compartments.
- 4.4 Driver and passenger compartments with insulation.
- 4.5 A/C factory installed front.
- 4.6 Factory tinting on all windows.

5.0 CAB AND CHASSIS:

- 5.1 Minimum payload of 3,000 pounds.
- 5.2 Minimum 135-inch wheelbase.
- 5.3 Sliding right-hand side load door with window.
- 5.4 Hinged rear doors with fixed windows in rear doors.

5.5 Tires and wheels: Five (5) radial tubeless tires.

5.6 Driver and passenger seats.

5.7 Front and rear bumpers, factory installed.

6.0 SAFETY ITEMS:

6.1 Outside mirrors, LH and RH, minimum 7" X 10" inside rearview mirror.

6.2 Door locks on all doors.

6.3 Seat belts on all seats.

6.4 Screen/cage, behind driver and passenger seats.

6.5 Airbags if available as OEM.

7.0 COLOR:

7.1 Fleet white.

8.0 CONDITIONS:

8.1 In addition to the equipment, the unit shall be equipped with all standard equipment specified by manufacturer for the model bid and shall comply with all EPA emission standards and meet all OSHA and DOT current standards and safety requirements.

8.2 All bidders must identify in their bid proposals any after-market parts or components not designed by the manufacturer (OEM) with reference to the vehicle or equipment being bid. Any after-market parts or components identified must have the company's name and associated warranties.

ITEM NO. 12

1.5-TON TRUCK, CHASSIS-CAB (4 X 2) WITH UTILITY BODY (DUAL REAR TIRES) SPECIFICATIONS

1.0 ENGINE:

- 1.1 A V-8 gasoline engine with a minimum of 265 net hp or approved equivalent.
- 1.2 Minimum 110 amp alternator, heavy-duty battery.

2.0 TRANSMISSION:

- 2.1 Automatic transmission.
- 2.2 Transmission oil-air cooler.

3.0 AXLES:

- 3.1 Manufacturer's standard rear axle ratio for specified engine-transmission combination.

4.0 PERFORMANCE ITEMS:

- 4.1 Factory installed gauges.
- 4.2 Power steering and power steering cooler.
- 4.3 Heavy-duty towing package, to include receiver.
- 4.4 With a minimum of thirty-five (35) gallon fuel tank capacity.

5.0 COMFORT ITEMS:

- 5.1 Armrests, both doors; sun visors, both sides.
- 5.2 Air conditioning, factory installed.
- 5.3 Factory tinting on all windows.

6.0 SAFETY ITEMS:

- 6.1 Outside mirrors, LH and RH sides, adjustable arm type, minimum size 6.75" X 9.5"; inside rearview mirror.
- 6.2 Power brakes, factory installed, antilock.

6.3 Electric back-up alarm.

6.4 Airbags to include side if available.

7.0 TIRES & WHEELS:

7.1 Seven (7) LT 225/70RX19.5 radial BSW tubeless highway or all-season tread tire, spare wheel, tire and rack, frame mounted.

7.2 Jack (three [3] ton) and tire tool to be included.

8.0 CHASSIS, FRAME, CAB:

8.1 15,000 GVWR.

8.2 Minimum eighty-four (84) inches cab to axle.

8.3 Front bumper, factory installed.

8.4 Front tow hooks or tow pins, may be dealer installed.

8.5 Long utility body to match cab to axle.

9.0 COLOR:

9.1 Fleet White.

10.0 CONDITIONS:

In addition to the equipment specified, the unit shall be equipped with all standard equipment specified by manufacturer for the model bid and shall comply with all EPA emission standards, and meet all OSHA and DOT current standards and safety requirements.

10.1 All bidders must identify in their bid proposals any after-market parts or components not designed by the manufacturer (OEM) with reference to the vehicle or equipment being bid. Any after-market parts or components identified must have the company's name and associated warranties.

10.2 Reflective tape required to meet all State and Federal guidelines.

11.0 OPTIONS:

11.1 Strobe warning lights.

- a. The unit shall be equipped with a four (4) light (two [2] front, two [2] rear) strobe light warning system. The strobe light installation kit shall be a Star Warning Systems Model RSK906P.4 from Star Headlight and Lantern company, Inc., telephone (585) 226-9500, website www.star1889.com. Front lights shall be clear, and rear lights shall be amber. This strobe light system shall be installed and operational when the vehicle is delivered.

ITEM NO. 13

1.5-TON TRUCK, CHASSIS-CAB (4 X 4) (DUAL REAR TIRES) WITH UTILITY BODY CRANE AND AIR COMPRESSOR SPECIFICATIONS

INTENT:

Unit to be used by Pasco County Utilities Water and Sewer Maintenance Sections and Fleet Maintenance Section. Units are service trucks with crane and air compressor.

1.0 ENGINE:

- 1.1 Gasoline engine, with a minimum of 285 net hp, or approved equivalent.
- 1.2 Minimum 115 amp alternator; heavy-duty battery.

2.0 TRANSMISSION:

- 2.1 Automatic Transmission.
- 2.2 Transmission oil-air cooler.

3.0 AXLES:

- 3.1 Manufacturer's standard rear axle ratio for specified engine-transmission combination.
- 3.2 Manual locking front hubs factory installed.
- 3.3 Limited slip rear axle.

4.0 PERFORMANCE ITEMS:

- 4.1 Factory installed gauges.
- 4.2 Power steering and power steering cooler.
- 4.3 Heavy-duty towing package.
- 4.4 With a minimum of thirty-five (35) gallon, fuel tank capacity.

5.0 COMFORT ITEMS:

- 5.1 Armrests, both doors; sun visors, both sides.
- 5.2 Air conditioning, factory installed.
- 5.3 Tinting on all windows. Factory installed.

6.0 SAFETY ITEMS:

- 6.1 Outside mirrors, LH and RH, adjustable arm type, minimum size 6.75" X 9.5"; inside rear-view mirror.
- 6.2 Power brakes. Factory installed with ABS.
- 6.3 Electric back-up alarm.
- 6.4 Air bags.
- 6.5 Side air bags if available as OEM.

7.0 TIRES & WHEELS:

- 7.1 Seven (7) radial BSW tubeless all-terrain tread tire, dual rear.
- 7.2 Spare wheel and tire.
- 7.3 Jack (three [3] ton) and tire tool to be included.

8.0 CHASSIS, FRAME, CAB:

- 8.1 Minimum 17,500 lbs. GVWR, factory certified.
- 8.2 Cab to axle to match requested body.
- 8.3 Front bumper, factory installed.
- 8.4 Front tow hooks or tow pins, may be dealer installed.

9.0 COLOR:

- 9.1 Fleet White.

10.0 CONDITIONS:

- 10.1 In addition to the equipment specified, the unit shall be equipped with all standard equipment specified by manufacturer for the model bid and shall comply with all EPA emission standards, and meet all OSHA and DOT current standards and safety requirements.

- 10.2 All bidders must identify in their bid proposals any after-market parts or components not designed by the manufacturer (OEM) with reference to the vehicle or equipment being bid. Any after-market parts or components identified must have the company's name and associated warranties.
- 10.3 Reflective tape required to meet all State and Federal guidelines.

11.0 OPTIONS (TO BE INCLUDED):

- 11.1 Body type model: Reading Cranemaster, CM6-132ALS or equal (see attached specifications). Needs crane reinforcement at right rear corner for a 5,000-lb. crane and manual outriggers. Twelve (12) gauge tread plate floor, rear panels, inside of bed, and tops of both sides. Body to be painted to match cab and chassis. Safety step type bumper; locking system on all outside compartments. Bar locks on both side of utility body. Compartments to have removable, reinforced shelves and bin dividers.
- 11.2 Crane model: Auto Crane 5005EH or equal (see specifications); electric, hydraulic, 5,000-lb. crane with a minimum fifteen (15) foot reach and a 5,000-lb. lifting capacity at five (5) feet.
- 11.3 Air compressor: Model Cambell Hausfield Horizontal Air Compressor TF460352H or equal (see specifications).
- 11.4 Heavy-duty trailer-towing equipment, factory installed, for trailers weighing up to 10,000 lbs. fully loaded. Includes, in addition to standard equipment, transmission oil-air cooler (may be dealer installed if factory installed not available); heavy-duty front and rear shock absorbers, numerically higher rear axle ratio; heavy-duty electrical system (same as base or larger); heavy-duty flasher; and heavy-duty wiring harness. Electronic trailer-brake controller installed inside cab (may be dealer installed if not offered from the factory).
- 11.5 Heavy-duty weight-distributing hitch receiver, installed for trailers weighing up to 10,000 lbs. fully loaded (Class III), combination pintle hook, 2-5/16" diameter ball with adapter, pin, and clip. Drawtite or approved equivalent.

Hitch Maker: _____

- 11.6 Strobe warning lights.
 - a. Unit shall be equipped with a four (4) light (two [2] front, two [2] rear) strobe light warning system. The strobe light installation kit shall be a Star Warning Systems Model No. RSK906P.4 from Star Headlight and Lantern Company, Inc., telephone (585) 226-9500, Website www.star1889.com. Front lights shall be clear, and rear lights shall be amber. This strobe light system shall be installed and operational when the vehicle is delivered.
- 11.7 Scotch lock connectors are not acceptable.

CRANEMASTER 6000



Model shown features optional manual out / crank down outriggers

For 15,000 # GVWR chassis with 60" and 84" CA (maximum 6000# capacity crane)

Models CM6-108A and CM6-132A – High front vertical compartment on curbside, vented with chain hold-downs for high bottle storage.

Modified models available:

Models CM6-108ALB and CM6-132ALB: Low front vertical compartment on curbside, vented with chain hold-downs for low bottle storage (in lieu of high vented bottle compartment).

Models CM6-108ALS and CM6-132ALS: Low front vertical compartment on curbside (in lieu of high vented bottle compartment).

Clear Door Openings

CM6-108A Approx wt.: 2400#

- A** 28 $\frac{3}{4}$ " x 33 $\frac{1}{4}$ " **D** 28 $\frac{3}{4}$ " x 58 $\frac{3}{4}$ "
- B** 45" x 11 $\frac{1}{2}$ "
- C** 20 $\frac{1}{4}$ " x 29 $\frac{1}{4}$ "

CM6-132A Approx wt.: 2870#

- A** 34 $\frac{1}{2}$ " x 33" **D** 20 $\frac{1}{4}$ " x 29 $\frac{1}{4}$ "
- B** 11" x 33" **E** 22" x 33"
- C** 47 $\frac{3}{4}$ " x 11 $\frac{1}{2}$ " **F** 22" x 58 $\frac{3}{4}$ "

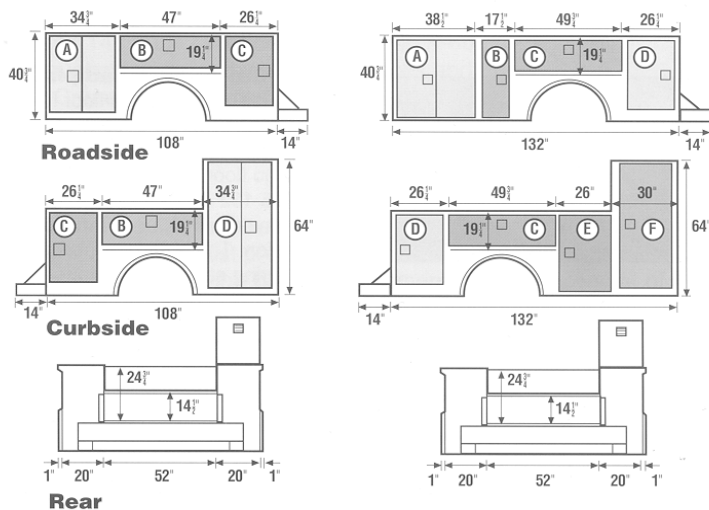

MANUAL OUTRIGGERS

Pin type manual out, manual crank down outrigger assembly (less bumper, with cross tube); maximum spread of 146" center to center of leg
Part Number 725572 (shown right)

Pin type manual out, manual down, telescoping outrigger assembly with pull pin base adjustment (less bumper, with cross tube); maximum spread of 145 1/2" center to center of leg

Part Number 725570

For use with trucks 14,500 GVW or less, and cranes 6,000 lb. capacity or less.

Notes:

1. Weld item B to truck frame extensions.

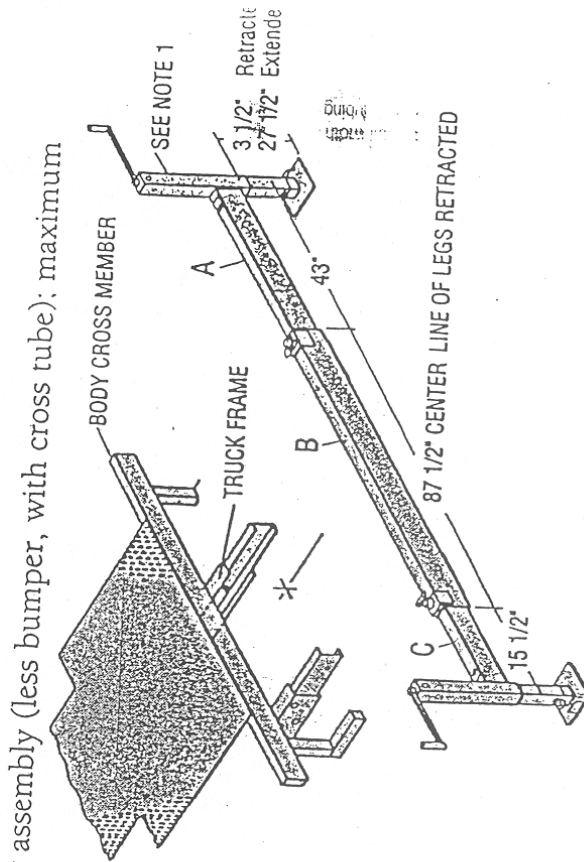

AIR COMPRESSOR

Horizontal, two (2) cylinder, two (2) stage, twelve (12) hp gasoline engine.

Campbell Hausfield TR460352H or equal or better.

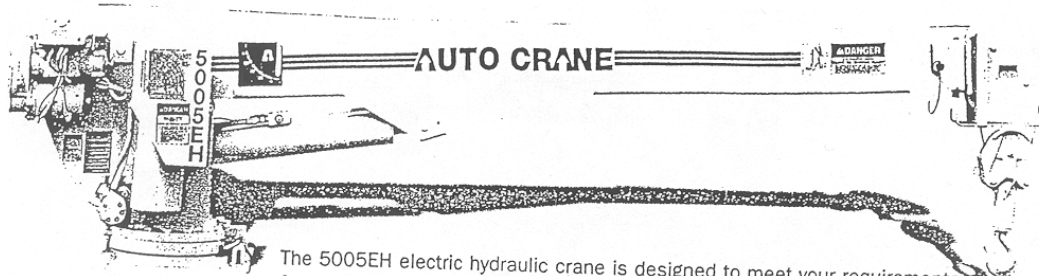

SERIES 5005EH

The 5005EH electric hydraulic crane is designed to meet your requirements for applications such as:

- Field service and installation
- Gas distribution service and installation
- Highway sign and roadside park maintenance
- Mining
- Monument/burial vault companies
- Pipeline companies
- Railroad signal departments and track maintenance
- Waste water treatment
- Workboats and barges

FEATURES:

- 5,000 lbs. (2,268 kgs) capacity
- Crane rating of 25,000 ft. lbs. (3.5 tm); maximum lifting capacity of 5,000 lbs. (2,268 kgs) at 5 ft. (1.5 m).
- Power boom extends from 10 ft. (3 m) to 16 ft. (4.8 m), with manual extension to 20 ft. (6.1 m); optional 10 ft. to 16 ft. power extension only
- 370° power rotation with positive locking
- Electric requirements are 24 volt DC supplied by the vehicle's 12 volt battery and auxiliary 12 volt battery (auxiliary battery not included)
- Automatic overload protection system
- Bail type anti-two block to minimize crown to hook distance
- 24 ft. (7.3 m) remote control pendant
- -5° to 75° hydraulically powered boom elevation
- 2.5 hp 24V DC electric hoist motor
- 80 ft. (24.3 m) of 5/16" (8 mm) aircraft quality cable
- Meets OSHA 1910.180 requirements
- Meets ANSI B30.5 safety standards
- IMRON™ 5000 paint (Auto Crane White)

LIFTING CAPACITIES:

REACH	RETRACTED BOOM 10' (3 m)		POWER BOOM EXTENSION 16' (4.8 m)		MANUAL BOOM EXTENSION 20' (6.1 m)	
	ft. (m)	lbs. (kgs)	lbs. (kgs)	lbs. (kgs)	lbs. (kgs)	lbs. (kgs)
3 (0.9)		5,000 (2,268)				
4 (1.2)		5,000 (2,268)				
5 (1.5)		5,000 (2,268)	5,000 (2,268)	5,000 (2,268)	5,000 (2,268)	5,000 (2,268)
6 (1.8)		4,170 (1,891)	4,170 (1,891)	4,170 (1,891)	4,170 (1,891)	4,170 (1,891)
7 (2.1)		3,570 (1,619)	3,570 (1,619)	3,570 (1,619)	3,570 (1,619)	3,570 (1,619)
8 (2.4)		3,125 (1,417)	3,125 (1,417)	3,125 (1,417)	3,125 (1,417)	3,125 (1,417)
9 (2.7)		2,775 (1,259)	2,775 (1,259)	2,775 (1,259)	2,775 (1,259)	2,775 (1,259)
10 (3.0)		2,500 (1,134)	2,500 (1,134)	2,500 (1,134)	2,500 (1,134)	2,500 (1,134)
11 (3.3)			2,270 (1,029)	2,270 (1,029)	2,270 (1,029)	2,270 (1,029)
12 (3.7)			2,080 (943)	2,080 (943)	2,080 (943)	2,080 (943)
13 (3.9)			1,920 (871)	1,920 (871)	1,920 (871)	1,920 (871)
14 (4.3)			1,785 (810)	1,785 (810)	1,785 (810)	1,785 (810)
15 (4.6)			1,665 (755)	1,665 (755)	1,665 (755)	1,665 (755)
16 (4.9)			1,560 (707)	1,560 (707)	1,560 (707)	1,560 (707)
17 (5.2)				1,470 (667)	1,470 (667)	1,470 (667)
18 (5.5)				1,390 (630)	1,390 (630)	1,390 (630)
19 (5.8)				1,315 (596)	1,315 (596)	1,315 (596)
20 (6.1)				1,250 (567)	1,250 (567)	1,250 (567)

SPECIFICATIONS:

Weight: 1,330 lbs. (604 kgs) for 20 ft. boom length, 1,110 lbs. (504 kgs) for 16 ft. boom length
 Length: 143.5" (364.5 cm)
 Width: 22.5" (57.2 cm)
 Height: 35.1" (89.2 cm)
 Base Plate Dimensions: 19.5" x 18.8" (49.5 cm x 47.8 cm)
 Min. Chassis Requirements: 10,500 lbs. (4,763 kgs) GVWR

(NOTE: Depending on the weights of body and ancillary equipment, a 10,500 GVWR truck may have limited additional payload. For increased capacity, a 14,500 GVWR is recommended.)

Truck must be equipped with 360300-001 outriggers, minimum 75 amp alternator, minimum 100 minute reserve capacity H.D. maintenance type battery with 500 cold cranking amp capacity.

Classic Series Air Compressors For Large Automotive And Industrial Applications

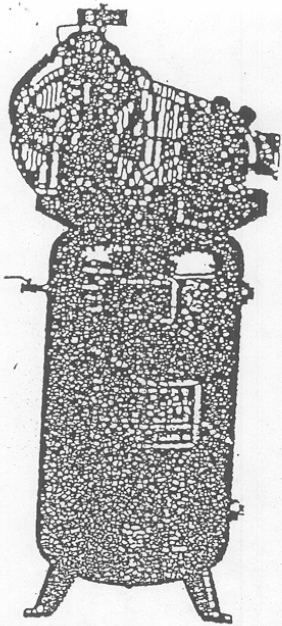

TF410821V

Classic Series models are designed for continuous duty applications that include production air tool operation, automobile repair and body shop use. These models deliver more air than our Premium Series models to allow for more users at one time.

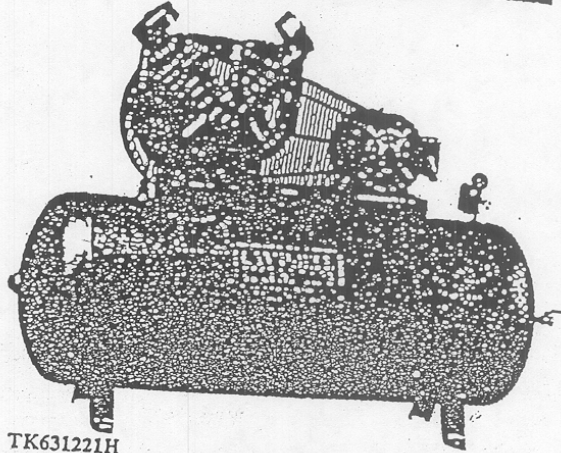

TK631221H

Commercial and industrial users who demand a rugged and reliable air compressor for their business count on Classic Series two-stage air compressors for years of dependable performance.

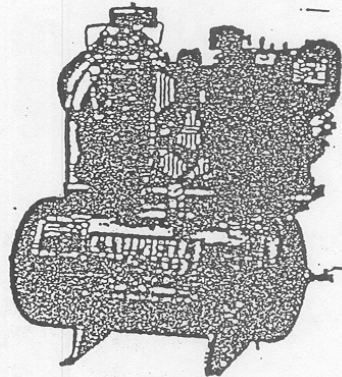

TF460352H

Classic Series Features:

- Durable cast iron cylinders
- Stainless steel valves
- Splash lubrication
- Optimum balanced ductile-iron crankshaft for smooth operation
- "Easy-to read" oil sight gauge
- ASME certified tanks
- One year warranty
- Permanent mold pistons
- Deep intercooler with interstage safety valve
- Dynamically balanced fan-type flywheel
- Industrial air filter/silencer for quiet operation

- Oversized tapered roller bearings for long life
- Continuous operating head unloaders prolong motor life by reducing the number of motor start-ups.
- Low operating pump speed
- Centrifugal unloader for load-free starting
- Die-cast head for heat dissipation
- Optimum balanced pistons for smoother operation

Dimensions

Two Stage Air Compressor Pumps, 5-10 HP

Model TF

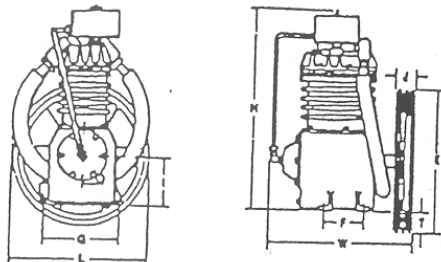

Model TK

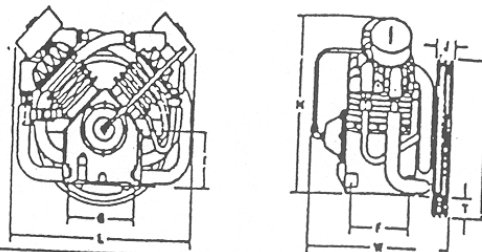

Motor HP	Model	Bore & Stroke 1st St. & 2nd St. & Str.	No. of Cyl.	Overall Dimensions (Inches)									Ship. Wt. lbs.
				L	W	H	F	G	J	T	K		
5	TF000021P	4 3/4 & 2 1/2 x 3	2	18.5	18.3	22	5.75	8.75	2.5	2.75	5.5	6.5	150.
	TF000051P												
10	TK000021P	4 3/4 & 2 1/2 x 3	4	25.0	19.5	20.5	8.06	9.63	2.5	2.69	7	16.5	245
	TK000051P												

Two Stage ASME Receiver Horizontal & Vertical Configurations

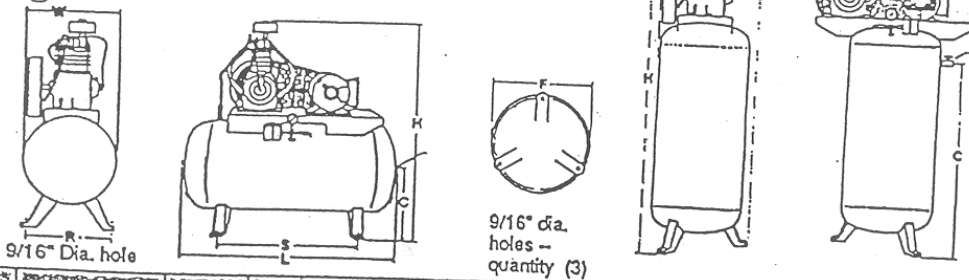

Motor HP	Model	No. of Cyl.	Overall Dimensions (Inches)							Shipping Weight lbs.	Vertical or Horizontal
			L	W	H	C	R	S	E		
5	TF410821H	2	68.0	23.0	49.0	14.0	18.0	45.0	—	582	H
5	TF430821H	2	68.0	23.0	49.0	14.0	18.0	45.0	—	582	H
10	TK631221H	4	74.0	26.0	54.0	15.75	19.63	46.0	—	828	H
12	TF460352H	2	42.0	19.0	42.25	12.25	15.75	18.0	—	475	H
5	TF410821V	2	33.0	25.0	79.0	42.0	—	—	27.0	582	V
5	TF430821V	2	33.0	25.0	79.0	42.0	—	—	27.0	582	V

iasolne Unit

Classic Series Specifications

Two-Stage Air Compressor Pumps, 5-10 HP

Motor HP	Model #	Pressure	Piston Displ.	Free Air Del.	RPM	Oil Capacity	Air Filter	Pipe Openings		V-Belts		
		PSI	SCFM	SCFM		QT.	No.	Type	In/Out NPT	No.	Size	
5	TF000021P TF000051P*	100	24.9	20.0	800	2	1	dry	1"	3/4"	2	B
		125	23.4	18.5	760							
		150	22.2	17.5	720							
		175	21.5	17.0	700							
10	TK000021P TK000051P*	100	49.3	37.6	800	5	2	dry	1"	3/4"	2	B
		125	46.5	36.0	760							
		150	46.2	35.6	720							
		175	43.1	34.0	700							

*Continuous run option pumps

Two-Stage, Electrical and Gasoline Horizontal Tank Configuration

Motor HP	Model #	No of Cyl.	Motor		Performance at 125 PSI			Performance at 175 PSI			ASME Tank Vol.	
			230 1ph.	208/230/460 3 ph.	Piston Displ.	Free Air Delivery	Comp RPM	Piston Displ.	Free Air Delivery	Comp RPM	Cu.ft.	US Gal.
5	TF410821H	2	X		23.4 CFM	18.5 CFM	760	21.5 CFM	17.0 CFM	700	10.7	80
5	TF430821H	2		X	23.4 CFM	18.5 CFM	760	21.5 CFM	17.0 CFM	700	10.7	80
10	TK631221H	4		X	46.5 CFM	36.0 CFM	760	43.1 CFM	34.0 CFM	700	16.0	120
12	TF460352H	2			23.4 CFM	18.5 CFM	760	21.5 CFM	17.0 CFM	700	4.0	30

Two-Stage, Electrical, Vertical Tank Configuration

Motor HP	Model #	No. of Cyl.	Motor		Performance at 125 PSI			Performance at 175 PSI			ASME Tank Vol.	
			230 1ph.	208/230/460 3 ph.	Piston Displ.	Free Air Delivery	Comp RPM	Piston Displ.	Free Air Delivery	Comp RPM	Cu. ft.	US Gal.
5	TF410821V	2	X		23.4 CFM	18.5 CFM	760	21.5 CFM	17.0 CFM	700	10.7	80
5	TF430821V	2		X	23.4 CFM	18.5 CFM	760	21.5 CFM	17.0 CFM	700	10.7	80

KERINS...FOR THE RIGHT COM

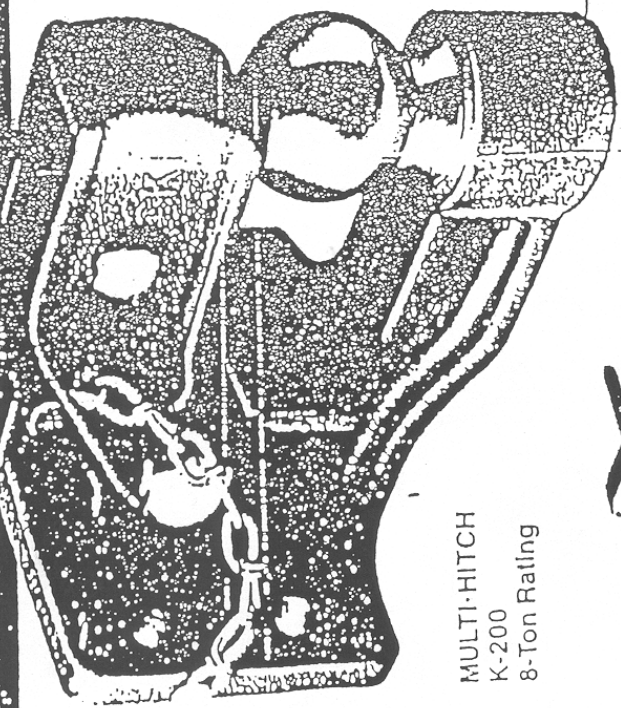

MULTI-HITCH
K-200
8-Ton Rating

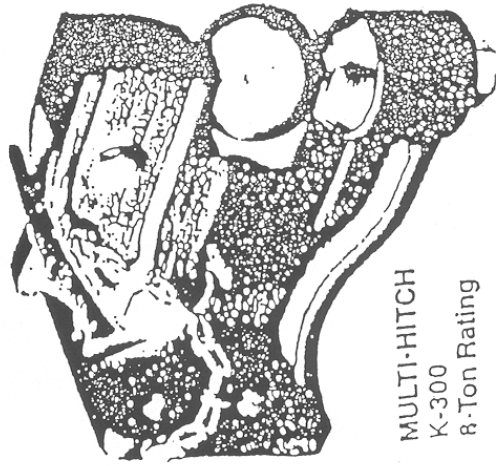

MULTI-HITCH
K-300
8-Ton Rating

MULTI-HITCH™ Series

MODEL K-200

Standard Equipment: 2" BALL, also allows Pintle Connection
 Optional Equipment: 1 1/2" BALL, also allows Pintle Connection
 2 3/4" BALL, ~~For Ball Connection Only~~

MODEL K-300

Standard Equipment: 2 3/4" BALL, also allows Pintle Connection
 Optional Equipment: 1 1/2" and 2" BALL, ~~For Ball Connection Only~~

- American Made
- Standard Mounting Pattern
- Interchangeable Ball: 1 1/2", 2", 2 3/4"
- Case Hardened Chrome or Nickel-Plated Steel Ball
- Accepts Rings up to 1 1/2" Thick
- Cast Steel Construction



Ball Hitch Application

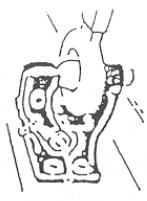

Pintle Hitch Application

NEW

HARD-TOP Safety System

For Ball or Pintle Connection

For Pintle Connection Only

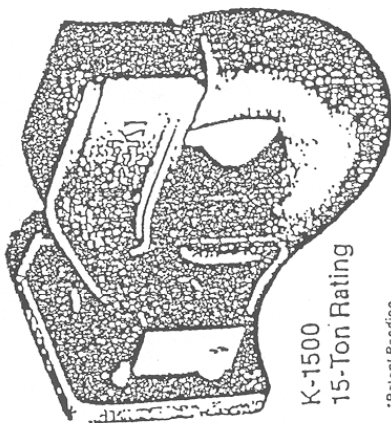

K-1500
15-Ton Rating

*Patent Pending

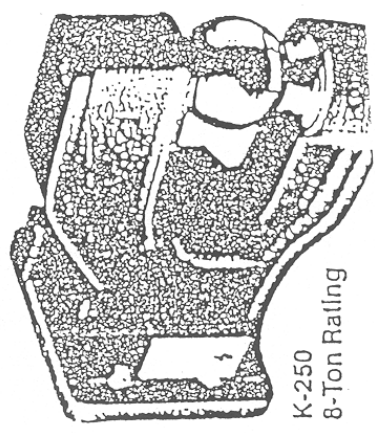

K-250
8-Ton Rating

ITEM NO. 14

½-TON BASIC CARGO VAN SPECIFICATIONS

1.0 ENGINE:

- 1.1 Gasoline engine, V-8.
- 1.2 Minimum 115-amp alternator; heavy-duty battery.

2.0 TRANSMISSION:

- 2.1 Automatic transmission.

3.0 PERFORMANCE ITEMS:

- 3.1 Factory-installed gauges.
- 3.2 Power steering.

4.0 COMFORT ITEMS:

- 4.1 Vinyl upholstery.
- 4.2 Vinyl trim on doors and side panels in passenger's compartment. Plain hardboard panels not acceptable.
- 4.3 Headliner with insulation over drive and passenger compartments.
- 4.4 Driver and passenger compartments with insulation.
- 4.5 A/C factory installed front.
- 4.6 Factory tinting on all windows.

5.0 CAB CHASSIS:

- 5.1 Minimum payload of 1,200 pounds.
- 5.2 Minimum 130-inch wheelbase.
- 5.3 Sliding right-hand side load door with window.
- 5.4 Hinged rear doors with fixed windows in rear doors.
- 5.5 Tires and wheels: Five (5) fifteen (15) or sixteen (16) inch radial tubeless tires.

- 5.6 Driver and passenger seats.
- 5.7 Front and rear bumpers, factory installed.

6.0 SAFETY ITEMS:

- 6.1 Outside mirrors, LH and RH, minimum 7" X 10" inside rearview mirror.
- 6.2 Door locks on all doors.
- 6.3 Seat belts on all seats.
- 6.4 Screen/Cage, behind driver and passenger seats.
- 6.5 Power breaks, ABS.
- 6.6 Air bags.

7.0 OPTIONS TO BE INCLUDED:

- 7.1 Vinyl mat for cargo area.

8.0 COLOR: Fleet White.

9.0 CONDITIONS:

In addition to the equipment, the unit shall be equipped with all standard equipment specified by manufacturer for the model bid and shall comply with all EPA emission standards and meet all OSHA and DOT current standards and safety requirements.

All bidders must identify in their bid proposals any aftermarket parts or components not designed by the manufacturer (OEM) with reference to the vehicle or equipment being bid. Any aftermarket parts or components identified must have the company's name and associated warranties.

ITEM NO. 15

$\frac{3}{4}$ -TON STYLESIDE BODY PICKUP TRUCK (4 X 4) WITH UTILITY BODY SPECIFICATIONS

12.0 ENGINE:

- 12.1 Gasoline engine, V*, minimum 5.4 L or approved equivalent.
- 12.2 Minimum ninety (90) amp alternator, heavy-duty battery.

13.0 TRANSMISSION:

- 13.1 Automatic transmission.
- 13.2 Two (2) speed transfer case; part-time four (4) wheel drive.
- 13.3 Heavy-duty trailer towing equipment (to include receiver).

14.0 AXLES:

- 14.1 Limited slip or locking differential on rear axle.

15.0 PERFORMANCE ITEMS:

- 15.1 Factory-installed gauges.
- 15.2 Power steering.

16.0 COMFORT ITEMS:

- 16.1 Factory air conditioning.
- 16.2 Factory tinting on all windows.

17.0 SAFETY ITEMS:

- 17.1 Outside mirrors, LH & RH sides; inside rearview mirror.
- 17.2 Power brakes. Factory installed with ABS.
- 17.3 Air bags.
- 17.4 Side air bags if available as OEM.

18.0 TIRES & WHEELS:

18.1 Five (five) sixteen (16) inch or larger radial BSW tubeless all terrain tread tires.

19.0 CHASSIS, FRAME, CAB:

19.1 Minimum of 8,500 GVW.

19.2 Fleetside or approved equivalent body, minimum 7'11" inside.

19.3 Front bumper, heavy-duty step-type rear bumper, both factory installed.

20.0 COLOR:

20.1 Fleet White.

21.0 CONDITIONS:

In addition to the equipment specified, the unit shall be equipped with all standard equipment specified by manufacturer for the model bid and shall comply with all EPA emission standards and meet all OSHA and DOT current standards and safety requirements.

All bidders must identify in their bid proposals any after-market parts or components not designed by the manufacturer (OEM) with reference to the vehicle or equipment being bid. Any after-market parts or components identified must have the company's name and associated warranties.

Reflective tape required to meet all State and Federal guidelines.

21.1 Manufacturer's line sheet shall be submitted upon delivery.

22.0 OPTIONS (TO BE INCLUDED):

22.1 Strobe warning lights.

- a. Unit shall be equipped with a four (4) light (two [2] front, two [2] rear) strobe light warning system. The strobe light installation kit shall be a Star Warning Systems Model No. RSK906P.4 from Star Headlight and Lantern Company, Inc., telephone (585) 226-9500, Website www.star1889.com. Front lights shall be clear, and rear lights shall be amber. This strobe light system shall be installed and operational when the vehicle is delivered.

22.2 Utility work body for 135-inch wheelbase truck in lieu of fleetside body.

ITEM NO. 16

ECONOMY PASSENGER VAN (4 X 2 or FWD) SPECIFICATIONS

1.0 ENGINE:

- 1.1 Gasoline engine, six (6) cylinder, 4.2 L or approved equivalent.
- 1.2 Minimum 110-amp alternator.

2.0 TRANSMISSION:

- 2.1 Automatic transmission. Transmission oil-air cooler.

3.0 AXLES:

- 3.1 Manufacturer's standard drive axle ratio for specified engine-transmission combination.

4.0 PERFORMANCE ITEMS:

- 4.1 Factory-installed gauges.
- 4.2 Power steering.

5.0 COMFORT ITEMS:

- 5.1 Factory tinting on all windows.
- 5.2 Vinyl trim on doors and side panels in passenger compartment. Plain hardboard panels not acceptable.
- 5.3 Headliner with insulation, driver area.
- 5.4 Rubber floor mats, driver and passenger compartments, with insulation.
- 5.5 Air conditioning, dual. Factory installed.

6.0 SAFETY ITEMS:

- 6.1 Outside mirror, LH and RH sides.
- 6.2 Power brakes. Factory installed. Antilock.
- 6.3 Interior dome lights, driver and passenger compartments.
- 6.4 Door locks on all doors.

- 6.5 Seat belts on all seats.
- 6.6 Back-up alarm.
- 6.7 Air bags, to include side air bags if available as OEM.
- 7.0 TIRES & WHEELS:
 - 7.1 Five (5) fourteen (14) inch or larger radial BSW all seasons tread tires.
- 8.0 CHASSIS, FRAME, CAB:
 - 8.1 Minimum 116-inch wheelbase.
 - 8.2 RH side load door; rear load door(s).
 - 8.3 Windows all around, factory tinted.
 - 8.4 Maximum heat and sound insulation available from manufacturer.
 - 8.5 Seating shall be manufacturer's standard arrangement for seven (7) passengers with a removable rear seat.
 - 8.6 Front and rear bumpers, factory installed.
- 9.0 CONDITIONS:
 - 9.1 In addition to the equipment specified, the unit shall be equipped with all standard equipment specified by manufacturer for the model bid and shall comply with all EPA emission standards, and meet all OSHA and DOT current standards and safety requirements.
 - 9.2 All bidders must identify in their bid proposals any after-market parts or components not designed by the manufacturer (OEM) with reference to the vehicle or equipment being bid. Any after-market parts or components identified must have the company's name and associated warranties.

ITEM NO. 17

ONE (1) TON PICKUP TRUCK, CREW CAB (4 X 4) WITH SURVEY EQUIPMENT SPECIFICATIONS

INTENT:

To be used as a land surveyor's vehicle. Vehicle will be used to transport equipment and up to four (4) passengers across various types of terrain such as woodlands, wetlands, pastures, and roadways Countywide.

1.0 ENGINE:

- 1.1 A V-8 engine with a minimum of 285 net hp.
- 1.2 Minimum 115-amp alternator, heavy-duty battery.

2.0 TRANSMISSION:

- 2.1 Automatic transmission.
- 2.2 Transmission oil-air cooler, factory installed.

3.0 AXLES:

- 3.1 Manufacturer's standard rear axle ratio for specified engine-transmission combination.
- 3.2 Heavy-duty towing equipment package to include a receiver.

4.0 PERFORMANCE ITEMS:

- 4.1 Factory gauges.
- 4.2 Power steering.

5.0 COMFORT ITEMS:

- 5.1 Air conditioning.
- 5.2 Factory tinting on all windows.
- 5.3 AM/FM radio, minimum.

6.0 SAFETY ITEMS:

- 6.1 Outside mirrors, junior west coast type, LH and RH sides, inside rearview mirror.
- 6.2 Power brakes, factory installed, ABS.
- 6.3 Air bags.

7.0 TIRES & WHEELS:

- 7.1 Five (5) all terrain tires, 33 X 12.5 X 16 BSW or equivalent larger on appropriate rims.

8.0 CHASSIS, FRAME, CAB:

- 8.1 Minimum pay load 3,000 lbs.
- 8.2 Minimum 131" wheel base.
- 8.3 Fleet side short bed.
- 8.4 Fuel tank and transmission skid plates.

9.0 COLOR:

- 9.1 White.
- 9.2 Vinyl interior, rubber floor mats.

10.0 CONDITIONS:

All bidders must identify in their bid proposals any after-market parts or components not designed by the manufacturer (OEM) with reference to the vehicle or equipment being bid. Any after-market parts or components identified must have the company's name and associated warranties.

- 10.1 Manufacturer's line sheet shall be submitted upon delivery.

11.0 REQUIRED OPTIONS TO BE INCLUDED:

- 11.1 Brush guard front bumper.
- 11.2 Heavy-duty towing package with flasher and wiring harness.
- 11.3 Silver Shield Field Organizer System for pickup truck or equivalent; one (1) each of security cover for one (1) ton pickup truck, two (2) each of "A" wheel well unit, one (1) each of "B" lower center storage unit, one (1) each of "C" upper center storage unit, and one (1) each of "D" pull-down desk.
- 11.4 Water cooler rack.

- 11.5 Cone rack.
- 11.6 Strobe warning lights: The unit shall be equipped with a four (4) light (two [2] front, two [2] rear) strobe light warning system. The strobe light installation kit shall be a Star Warning Systems Model "RSK906P.4" from Star Headlight and Lantern Co., Inc., telephone (585) 266-9500, website www.star1889.com. This strobe light system shall be installed and operational when the vehicle is delivered.

Silver Shield

Order
TOLL FREE: (811)
FAX: 6



Security Cover



Field Organizer



Typical Uses



Testimonials



About Us



Call for Catalog or to Place an Order

© 1998, 1999,
Silver Shield,
Phoenix, AZ.
All Rights Reserved

Modern, Galvanized Steel Field Organizer System

Helps save space
Sits off to wheelwells
Keeps equipment
clean with removable
lids

Click the "Field Organizer" link at left to go back

Two Each of "A"

A Wheelwell Unit

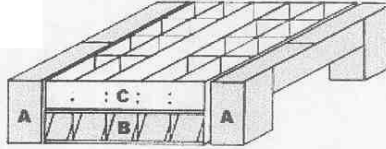

Versatility:	Organizes wasted space over and around wheelwell. Sits over wheelwell on either side. Center compartment is adjustable to the depth of wheelwell (Lids provide work surfaces (8"x27").
---------------------	--

Compartments:	3 - two on sides 8"x8"x15" and one in center 39"x8"x(4"-9" ac
----------------------	---

Specifications:	Material: Constructed of 16 & 20 gauge galvanized steel. Length: 55" / Width: 8" / Depth: 15" / Weight: 42 lbs.
------------------------	--

One Each of "B"

B Lower Center Storage Unit

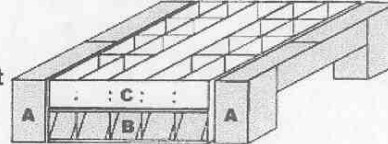

Versatility:	Organizes space between wheelwells. Adjustable (27"-48", 1" increments). Adjustable rear panels allow variable-size open-end compartments to accommodate longer items.
---------------------	--

Compartments:	5 - adjustable in 1" increments.
----------------------	----------------------------------

Specifications:	Material: 20 gauge galvanized steel with 3/8" plywood floor. Length: 55" / Width: 27"-48", 1" increments / Depth: 8" / Weight: 15 lbs.
------------------------	---

One Each of "C"

C Upper Center Storage Unit

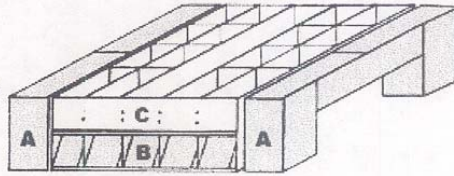

Versatility:	Organizes space between wheelwells. Doubles capacity of lower unit. Adjustable (27"-48", 1" increments).
---------------------	--

Compartments:	Small dividers adjustable in 4.75" increments, allowing up to compartments.
----------------------	---

Specifications:	Material: 20 gauge galvanized steel. Length: 55" / Width: 27"-48", 1" increments / Depth: 8" / Weight: lbs.
------------------------	--

37 Years of Quality Craftsmanship
Thank you for visiting our site!



Security Cover



Field Organizer



Typical Uses



Testimonials



About Us



Call for Catalog or to Place an Order

© 1998, 1999,
Silver Shield,
Phoenix, AZ.
All Rights Reserved

Medium Galvanized Steel
Field Organizer System

Pickup truck
Sport Utility Vehicle
Van
Custom van parts
Accessories with 10mm

Click the "Field Organizer" link at left to go back

One Each of "D"

D Pull-Down Desk



Versatility:	Provides instant working desk when you need it. Provides extra storage space for drawing gear, light valuable. Can be installed for access from either driver or passenger side. Hinges to cover and is stored within Security Cover's curvature. Extends to edge of pickup rail or a few inches further.
---------------------	---

Specifications:	All Aluminum construction. Length: 48" / Width: 36" / Depth: 2"
------------------------	--

Silver Shield SYSTEM



Security Cover



Field Organizer



Typical Uses



Testimonials



About Us



Call for Catalog or to Place an Order

37 Years of Quality Craftsmanship
Thank you for visiting our site!

37 Years of Quality Craftsmanship
Thank you for visiting our site!
© 1998, 1999,
Silver Shield,
Phoenix, AZ.
All Rights Reserved

Typical Uses of the Silver Shield Security Cover & Field Organizer System

One Each

Click the "Typical Uses" link at left to go back.

A) Typical for Surveyors, Engineers & Contractors

1. Water Cooler
2. Lunch Box
3. Safety Cones
4. Flagging & Tst aid
5. Chief Party's Tool Belt, etc.
6. Brief Case
7. Blueprints, etc.
8. Steel Tapes
9. Nails
10. Instrument / Rod Person's Tool Belt, Hammer, etc.
11. Prism Bags
12. EDM, Transit, etc.
13. Level
14. Hubs: 6", 10", 12"
15. Laths: 1", 2", 3" and Stakes
16. Paint Cans
17. Stake Bag & Safety Hat
18. Radio Bag
19. Tripods
20. Rod, Prism & Range Poles
21. Frost Pin, Bar & Robar
22. Magnetic Locator, Shovel, etc.
23. Extra Space

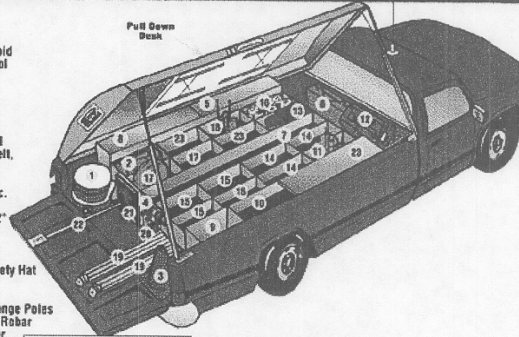

Silver Shield cover has been extended in illustration for clarity

ITEM NO. 18

½-TON STYLESIDE BODY PICKUP TRUCK (4 X 4) SPECIFICATIONS

1.0 ENGINE:

- 1.1 Gasoline engine, six (6) cylinder.
- 1.2 Minimum ninety (90) amp alternator; heavy-duty battery.

2.0 TRANSMISSION:

- 2.1 Automatic transmission.

3.0 AXLES:

- 3.1 Manufacturer's standard rear axle ratio for specified engine-transmission combination.
- 3.2 Transfer case. Part-time four (4) wheel drive

4.0 PERFORMANCE ITEMS:

- 4.1 Factory-installed gauges.
- 4.2 Power steering.

5.0 COMFORT ITEMS:

- 5.1 Factory air conditioning.
- 5.2 Factory tinting on all windows.

6.0 SAFETY ITEMS:

- 6.1 Outside mirrors, LH and RH sides; inside rearview mirror.
- 6.2 Power brakes, factory installed with ABS.
- 6.3 Air bags.
- 6.4 Side air bags if available as OEM.

7.0 TIRES & WHEELS:

- 7.1 Five (5) sixteen (16) inch or larger radial tubeless BSW all-terrain tread tires. Spare tire and wheel.

8.0 CHASSIS, FRAME, CAB:

8.1 Styleside or approved equivalent body, minimum 7'11" inside.

8.2 Front bumper, heavy-duty step-type rear bumper, both factory installed.

9.0 COLOR:

9.1 Fleet White.

10.0 CONDITIONS:

10.1 In addition to the equipment specified, the unit shall be equipped with all standard equipment specified by manufacturer for the model bid and shall comply with all EPA emission standards and meet all OSHA and DOT current standards and safety requirements.

10.2 All bidders must identify in their bid proposals any after-market parts or components not designed by the manufacturer (OEM) with reference to the vehicle or equipment being bid. Any after-market parts or components identified must have the company's name and associated warranties.

10.3 Reflective tape required to meet all State and Federal guidelines.

10.4 Manufacturer's line sheet shall be submitted upon delivery.

11.0 OPTIONS (TO BE INCLUDED):

11.1 Heavy-duty towing package to include receiver.

11.2 Strobe warning lights.

- a. Unit shall be equipped with a four (4) light (two [2] front, two [2] rear) strobe light warning system. The strobe light installation kit shall be a Star Warning Systems Model No. RSK906P.4 from Star Headlight and Lantern Company, Inc., telephone (585) 226-9500, Website www.star1889.com. Front lights shall be clear, and rear lights shall be amber. This strobe light system shall be installed and operational when the vehicle is delivered.

ITEM NO. 19

ONE (1) TON BASIC CARGO VAN SPECIFICATIONS

1.0 ENGINE:

- 1.1 Gasoline engine, V-8, minimum of 5.4 L.
- 1.2 Minimum 110-amp alternator; heavy-duty battery.

2.0 TRANSMISSION:

- 2.1 Automatic transmission.

3.0 PERFORMANCE ITEMS:

- 3.1 Factory-installed gauges.
- 3.2 Power steering.
- 3.3 Antilock brakes.

4.0 COMFORT ITEMS:

- 4.1 Vinyl upholstery.
- 4.2 Vinyl trim on doors and side panels in passenger's compartment. Plain hardboard panels not acceptable.
- 4.3 Headliner, full length with insulation.
- 4.4 Driver and passenger compartments with insulation.
- 4.5 A/C factory installed front.
- 4.6 Factory tinting on all windows.

5.0 SAFETY ITEMS:

- 5.1 Minimum payload of 4,000 pounds.
- 5.2 Minimum 135-inch wheelbase.
- 5.3 Tow hooks.
- 5.4 Sliding right-hand side load door with window.

- 5.5 Hinged rear doors with fixed windows in rear doors.
- 5.6 Tires and wheels: Five (5) radial tubeless tires.
- 5.7 Driver and passenger seats.
- 5.8 Front and rear bumpers, factory installed.
- 5.9 Vinyl floor covering, full floor length.
- 6.0 SAFETY ITEMS:
 - 6.1 Outside mirrors, LH and RH, minimum 7" X 10" inside rearview mirror.
 - 6.2 Door locks on all doors.
 - 6.3 Seat belts on all seats.
 - 6.4 Screen/cage, behind driver and passenger seats.
 - 6.5 Airbags if available as OEM.
- 7.0 COLOR:
 - 7.1 Fleet white.
- 8.0 CONDITIONS:
 - 8.1 In addition to the equipment, the unit shall be equipped with all standard equipment specified by manufacturer for the model bid and shall comply with all EPA emission standards and meet all OSHA and DOT current standards and safety requirements.
 - 8.2 All bidders must identify in their bid proposals any after-market parts or components not designed by the manufacturer (OEM) with reference to the vehicle or equipment being bid. Any after-market parts or components identified must have the company's name and associated warranties.
 - 8.3 Reflective tape required to meet all State and Federal guidelines.
 - 8.4 Manufacturer's line sheet shall be submitted upon delivery.
- 9.0 ADDITIONAL EQUIPMENT (TO BE INCLUDED):
 - 9.1 Towing package to include receiver.
 - 9.2 Shelves/binds inside cargo area (i.e., electrical services).
 - 9.3 Ladder rack on van roof.

END OF SPECIFICATIONS

BID FORM

Business Name: _____

Item No.	Quantity	Description	Unit Price	Total
1.	15 Each	Compact Pickup Truck (4 X 2) Extended Cab (Per Specifications and Conditions of the Bid Document or Equal) Manufacturer: _____ Model: _____ Year: _____ Warranty: _____ Delivery: _____	\$ _____	\$ _____
2.	6 Each	Compact Pickup Truck (4 X 2) Extended Cab (Per Specifications and Conditions of the Bid Document or Equal) Manufacturer: _____ Model: _____ Year: _____ Warranty: _____ Delivery: _____	\$ _____	\$ _____
3.	11 Each	½-Ton Styleside Body Pickup Truck (4 X 2) (Per Specifications and Conditions of the Bid Document or Equal) Manufacturer: _____ Model: _____ Year: _____ Warranty: _____ Delivery: _____	\$ _____	\$ _____

Item No.	Quantity	Description	Unit Price	Total
4.	3 Each	¾-Ton Styleside Body Pickup Truck (4 X 2) (Per Specifications and Conditions of the Bid Document or Equal) Manufacturer: _____ Model: _____ Year: _____ Warranty: _____ Delivery: _____	\$ _____	\$ _____
5.	2 Each	Large Mid-Size Vehicle, Four (4) Door Sedan (Per Specifications and Conditions of the Bid Document or Equal) Manufacturer: _____ Model: _____ Year: _____ Warranty: _____ Delivery: _____	\$ _____	\$ _____
6.	2 Each	¾-Ton Styleside Body Pickup Truck (4 X 4) (Per Specifications and Conditions of the Bid Document or Equal) Manufacturer: _____ Model: _____ Year: _____ Warranty: _____ Delivery: _____	\$ _____	\$ _____

Item No.	Quantity	Description	Unit Price	Total
7.	2 Each	Full-Size Utility Vehicle (4 X 4) (Per Specifications and Conditions of the Bid Document or Equal) Manufacturer: _____ Model: _____ Year: _____ Warranty: _____ Delivery: _____	\$ _____	\$ _____
8.	2 Each	Four-Door Utility Vehicle (4 X 4) (Per Specifications and Conditions of the Bid Document or Equal) Manufacturer: _____ Model: _____ Year: _____ Warranty: _____ Delivery: _____	\$ _____	\$ _____
9.	2 Each	One (1) Ton Pickup Truck, Crew Cab (4 X 2) Dual Rear Wheels (Per Specifications and Conditions of the Bid Document or Equal) Manufacturer: _____ Model: _____ Year: _____ Warranty: _____ Delivery: _____	\$ _____	\$ _____

Item No.	Quantity	Description	Unit Price	Total
10.	3 Each	¾-Ton Pickup Truck with Utility Body (4 X 2) (Per Specifications and Conditions of the Bid Document or Equal) Manufacturer: _____ Model: _____ Year: _____ Warranty: _____ Delivery: _____	\$ _____	\$ _____
11.	1 Each	¾-Ton Basic Cargo Van (Per Specifications and Conditions of the Bid Document or Equal) Manufacturer: _____ Model: _____ Year: _____ Warranty: _____ Delivery: _____	\$ _____	\$ _____
12.	1 Each	1.5-Ton Truck, Chassis-Cab (4 X 2) with Utility Body, Dual Rear Tires (Per Specifications and Conditions of the Bid Document or Equal) Manufacturer: _____ Model: _____ Year: _____ Warranty: _____ Delivery: _____	\$ _____	\$ _____

Item No.	Quantity	Description	Unit Price	Total
13.	3 Each	<p>1.5-Ton Truck, Chassis-Cab (4 X 4), Dual Rear Tires with Utility Body Crane and Air Compressor (Per Specifications and Conditions of the Bid Document or Equal)</p> <p>Manufacturer: _____</p> <p>Model: _____</p> <p>Year: _____</p> <p>Warranty: _____</p> <p>Delivery: _____</p> <p>Utility Body:</p> <p>Manufacturer: _____</p> <p>Warranty: _____</p> <p>Crane:</p> <p>Manufacturer: _____</p> <p>Warranty: _____</p> <p>Air Compressor:</p> <p>Manufacturer: _____</p> <p>Warranty: _____</p>	\$ _____	\$ _____
14.	1 Each	<p>½-Ton Basic Cargo Van (Per Specifications and Conditions of the Bid Document or Equal)</p> <p>Manufacturer: _____</p> <p>Model: _____</p> <p>Year: _____</p> <p>Warranty: _____</p> <p>Delivery: _____</p>	\$ _____	\$ _____

Item No.	Quantity	Description	Unit Price	Total
15.	1 Each	¾-Ton Styleside Body Pickup Truck (4 X 4) with Utility Body (Per Specifications and Conditions of the Bid Document or Equal) Manufacturer: _____ Model: _____ Year: _____ Warranty: _____ Delivery: _____	\$ _____	\$ _____
16.	1 Each	Economy Passenger Van (4 X 2 or FWD) (Per Specifications and Conditions of the Bid Document or Equal) Manufacturer: _____ Model: _____ Year: _____ Warranty: _____ Delivery: _____	\$ _____	\$ _____

Item No.	Quantity	Description	Unit Price	Total
17.	1 Each	One (1) Ton Pickup Truck, Crew Cab (4 X 4) with Survey Equipment (Per Specifications and Conditions of the Bid Document or Equal) Manufacturer: _____ Model: _____ Year: _____ Warranty: _____ Delivery: _____ Survey Equipment: _____ _____	\$ _____	\$ _____
18.	3 Each	½-Ton Styleside Body Pickup Truck (4 X 4) (Per Specifications and Conditions of the Bid Document or Equal) Manufacturer: _____ Model: _____ Year: _____ Warranty: _____ Delivery: _____	\$ _____	\$ _____

Item No.	Quantity	Description	Unit Price	Total
19.	1 Each	One (1) Ton Basic Cargo Van (Per Specifications and Conditions of the Bid Document or Equal) Manufacturer: _____ Model: _____ Year: _____ Warranty: _____ Delivery: _____	\$ _____	\$ _____
GRAND TOTAL (Only if Bidding All Items)				\$ _____

All quantities represented are minimum estimated amounts of vehicles that Pasco County will be ordering in the Fiscal Year 2006-2007, which starts October 1, 2006. The total amount is not known at this time. All orders will be placed after BCC approval.

All equipment is to be the manufacturer's latest current Model Year 2007. 2008 models may be substituted after the factory cutoff dates providing the vendor will hold the bid price. No increases will be allowed. Please bid accordingly.

"We offer to sell/provide Pasco County, Florida, the above item(s) and/or service(s) at the price(s) stated, in accordance with the terms and conditions contained herein. In addition, the item(s) and/or service(s) offered above meet all specifications contained herein or attached, unless otherwise stipulated by exception. This offer to sell/provide is firm for ninety (90) days."

(Signature of Bidder—Ink)

(Printed Name and Title)

(Business Name)

Receipt of Addendum No. _____ through No. _____ is acknowledged.

Business Name: _____
(The Name on File with the Internal Revenue Service)

Doing Business as (Fictitious Name): _____

Business Organization:

Corporation:

Partnership: General Limited

Limited Liability Company (LLC):

State Registered In: _____ Year: _____

Sole Proprietorship: Owner: _____

Other: _____

Telephone: _____

Facsimile: _____

Address: _____

Date: _____, _____